



醒狮 (金)  
DANCING LION(GOLD)  
P141-GRN

拼装说明书

拼装提示 TIPS:

本产品采用扣点与扣位卡扣拼折的拼装方式，未发生拼装损坏，无需使用胶水 

建议购买并使用拼酷正品拼装工具， T-SKQ05 水口钳  ， T-JZQ05 尖嘴钳  ， 拼装更省时省力，作品更精细美观！

请参照包装内说明书进行拼装，请勿反复拼折金属零件，以免损坏。

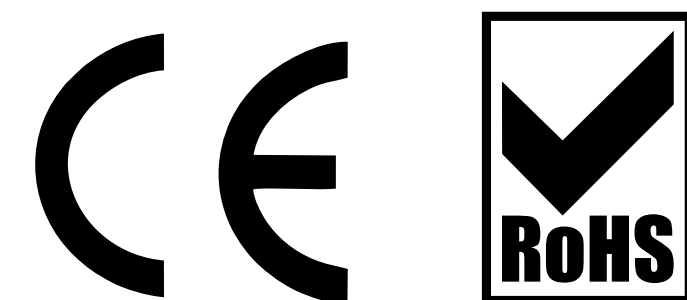

AGES 14+

本产品为金属制品，14岁以下需由成人陪同完成！

醒狮 (金)  
DANCING LION(GOLD)  
P141

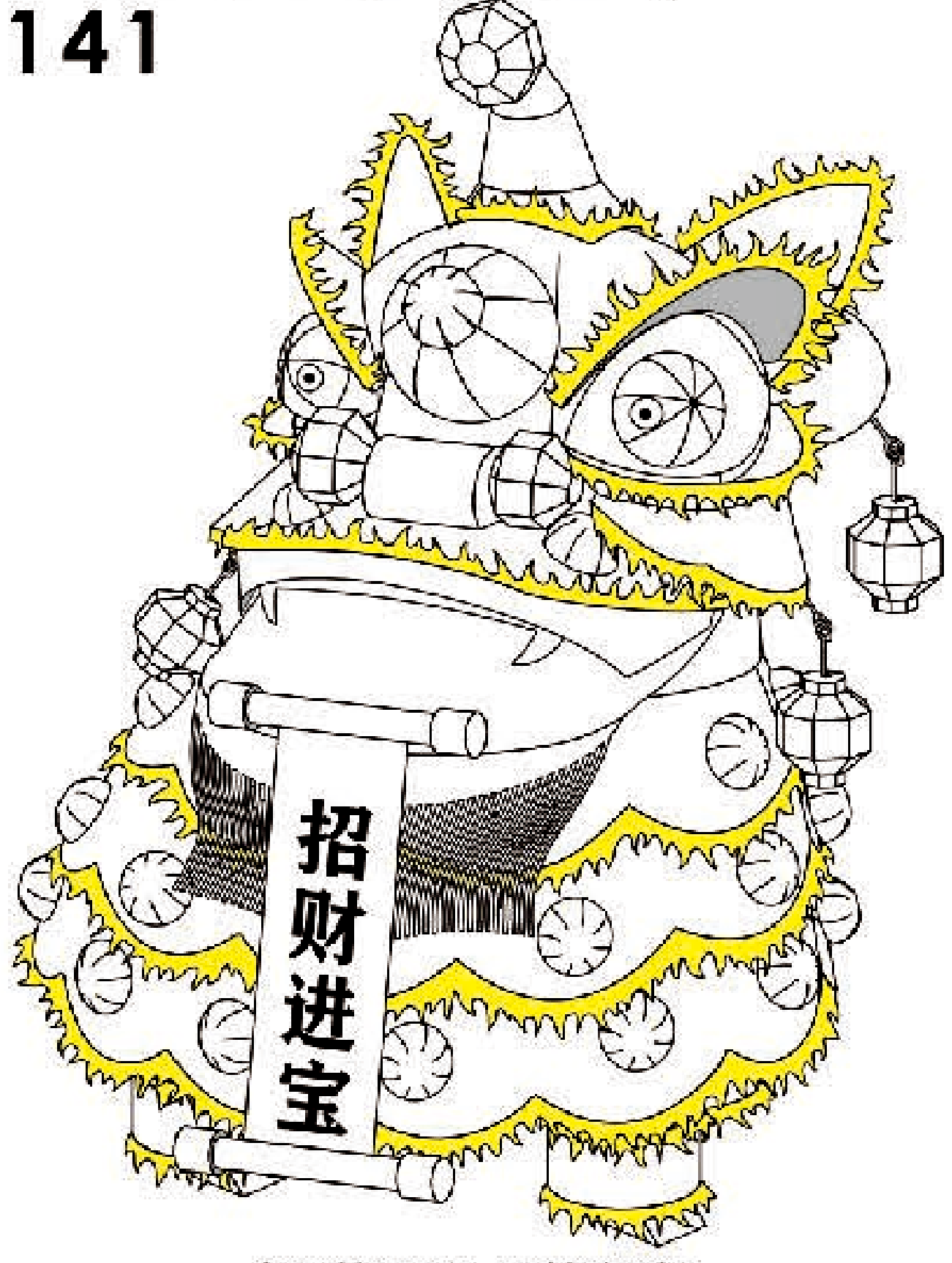

CP-ASSY-P141-A1-20191126

拼前需知

● 准备工具：

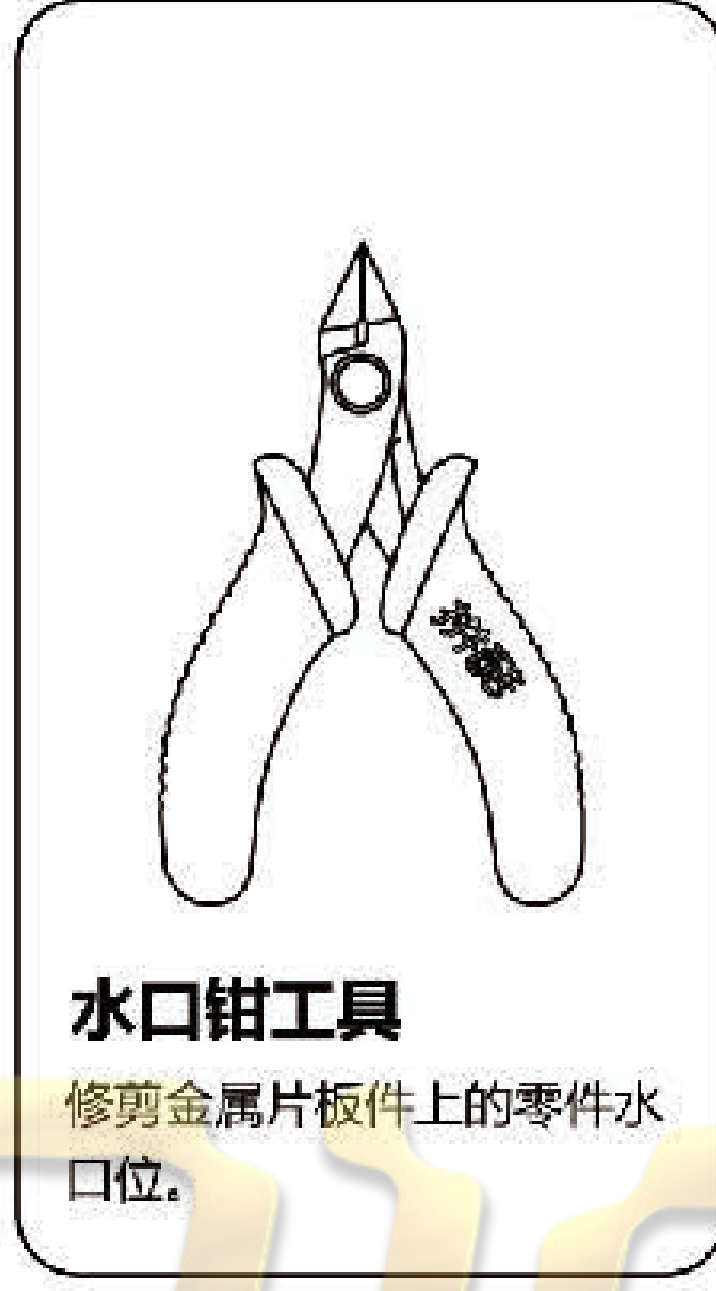

水口钳工具  
修剪金属片板件上的零件水口位。

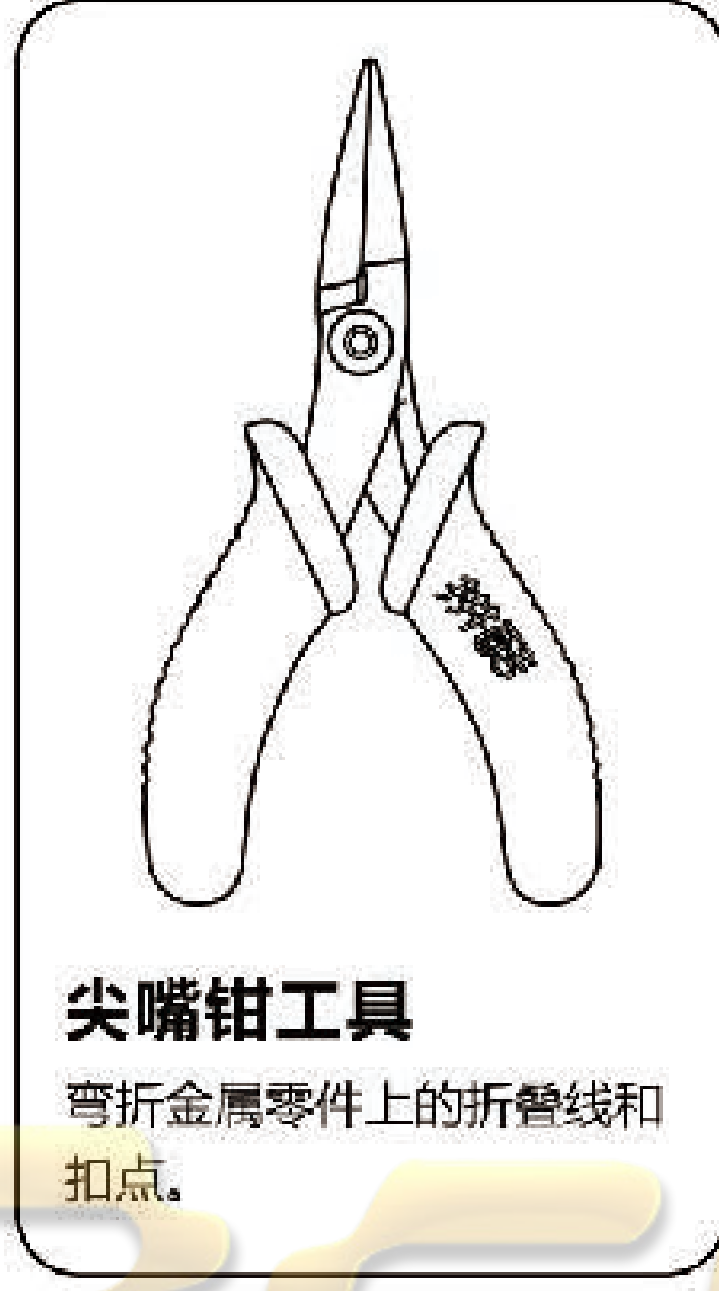

尖嘴钳工具  
弯折金属零件上的折管线和扣点。

建议使用拼酷正品拼装工具（水口钳、尖嘴钳），拼装时更省心、省力，拼装后作品更精细、美观！

⚠️ 组装时请小心处理金属零件，以防划伤

● 拼装方法：

a. 取下零件

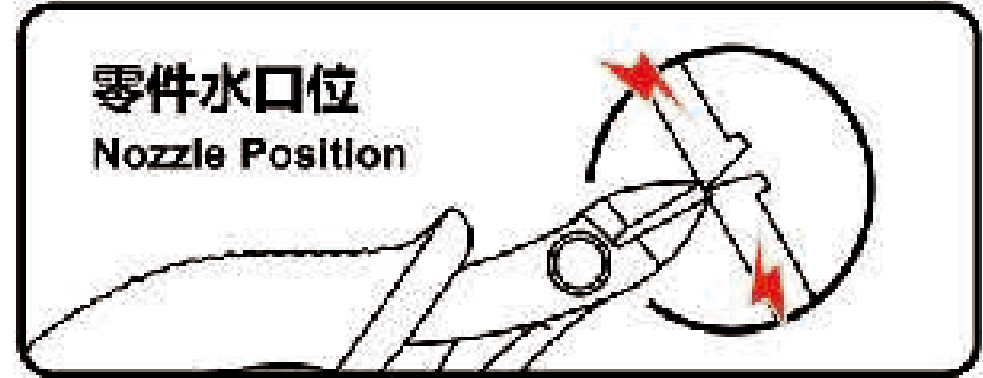

使用水口钳剪断金属零件上的水口，将需要的金属零件从金属片板件取下。

b. 识别零件

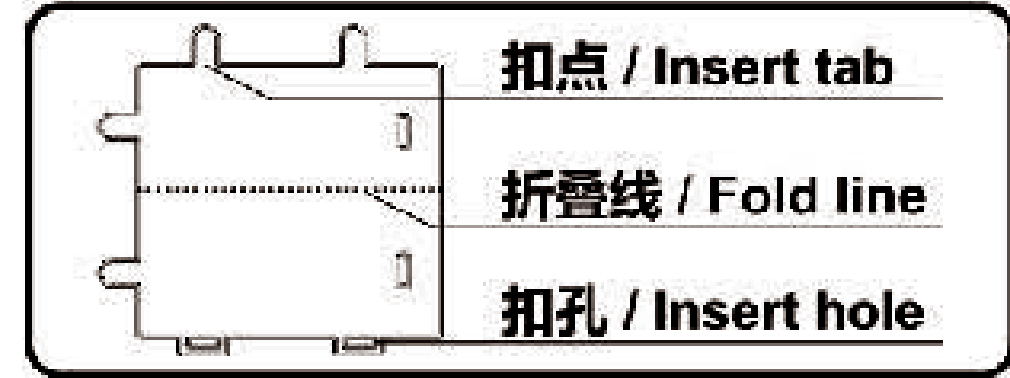

识别金属零件上的扣点、折管线、扣孔的样子。

c. 折叠零件

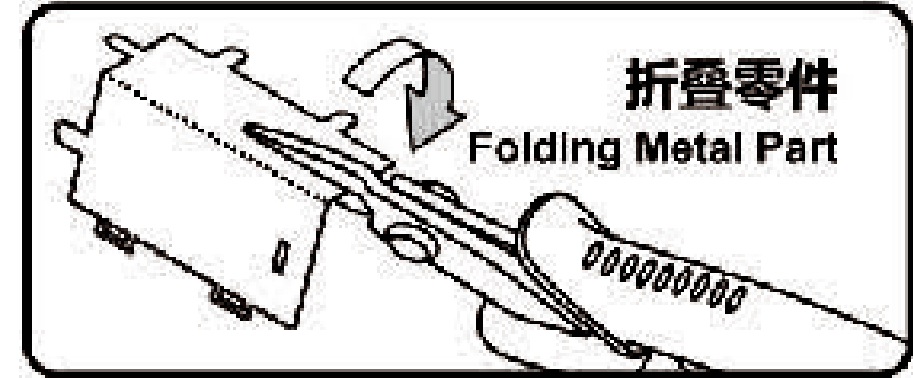

使用尖嘴钳，参照拼装说明书将金属零件折成形状。

d. 固定零件



● 插入扣孔，平折 90°

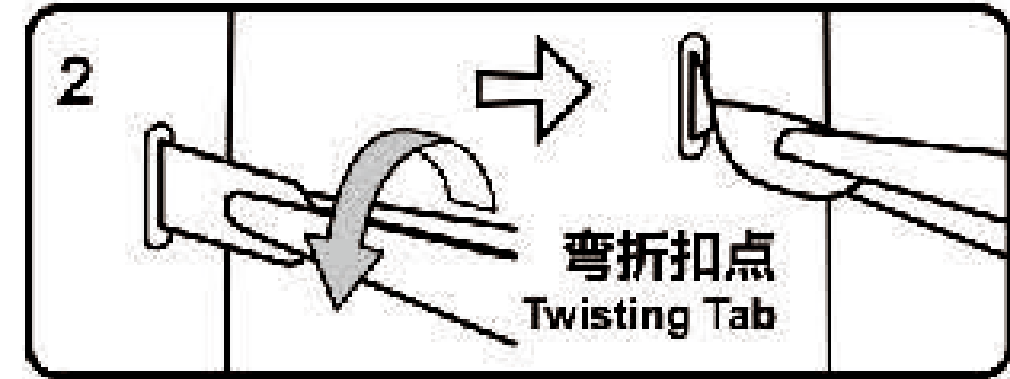

▲ 插入扣孔，旋转 90°

● 注意事项：

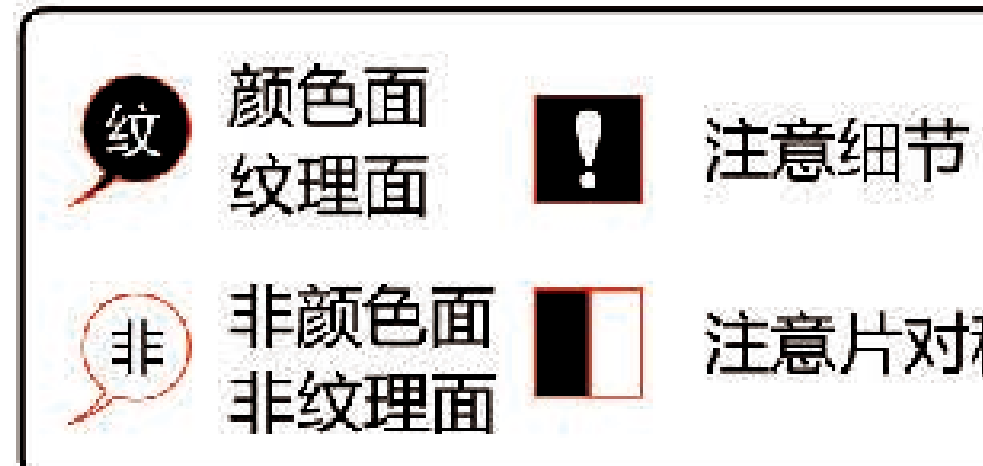

剪金属零件时请剪零件“水口位”，请勿将“扣点”当成“水口位”剪下，每次剪零件时请仅剪当前步骤的零件，切勿一次性将所有零件全部剪下，避免丢失；  
当遇到折叠线的零件，请注意金属片的正反面及拼折方向，请按照说明书说明的方向，轻柔慢折，最好一次折叠完成，请勿反复折叠，避免零件损坏。

拼装步骤

Step 1

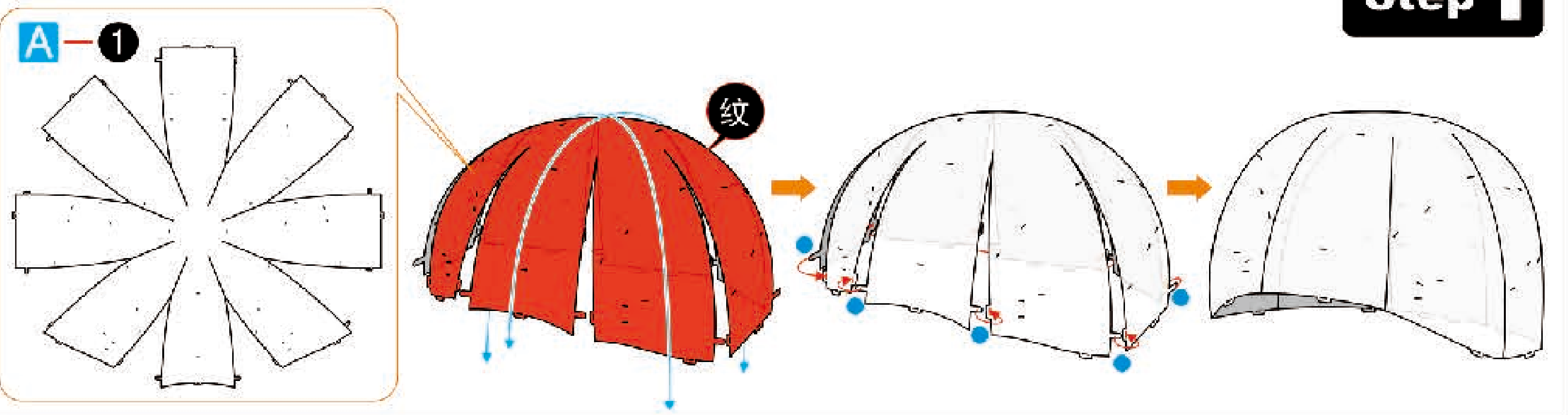

Step 2

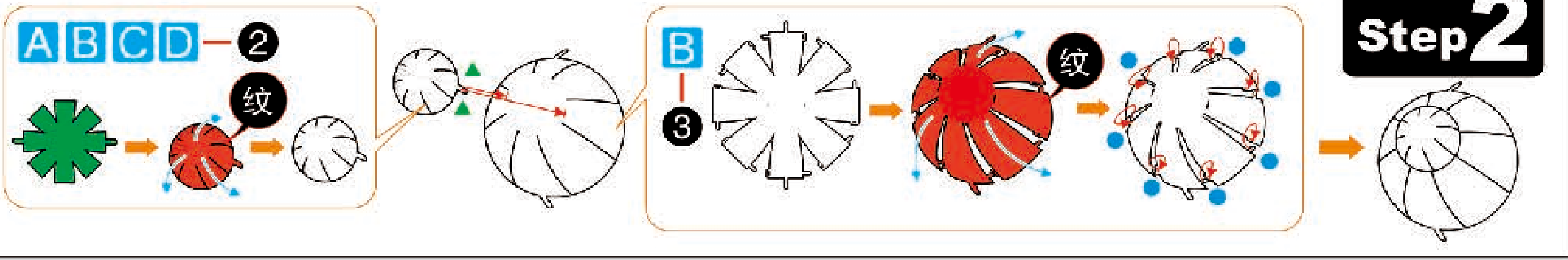

Step 3

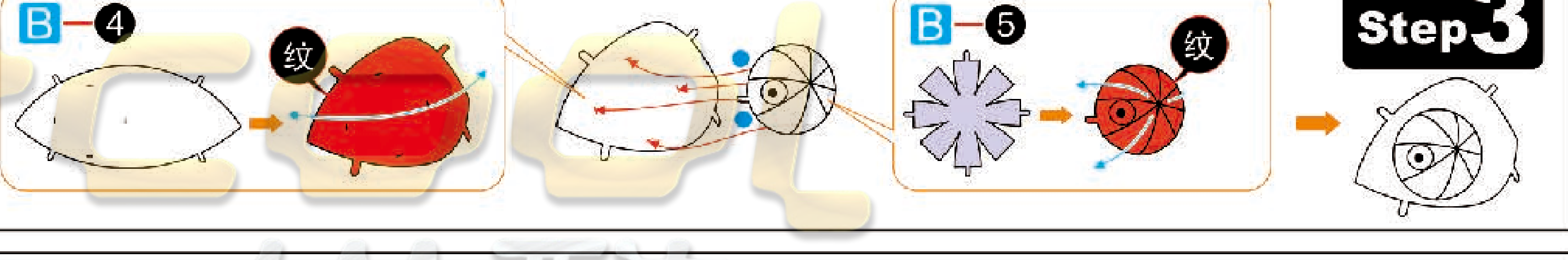

Step 4

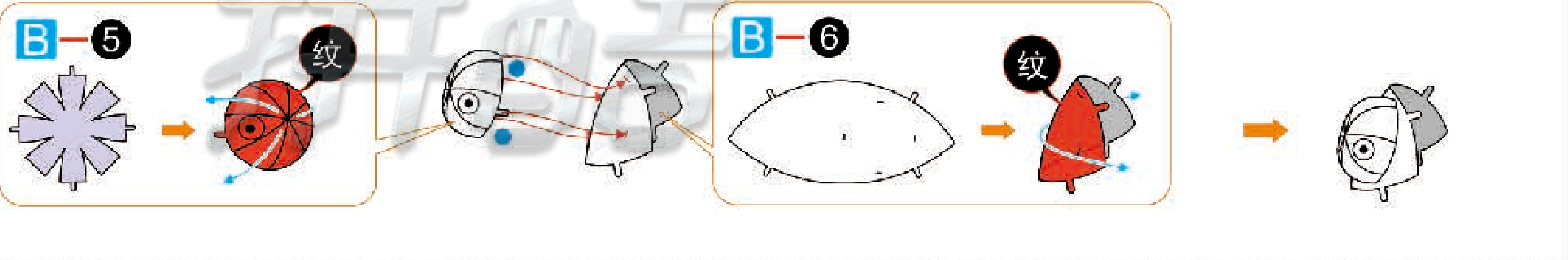

Step 4

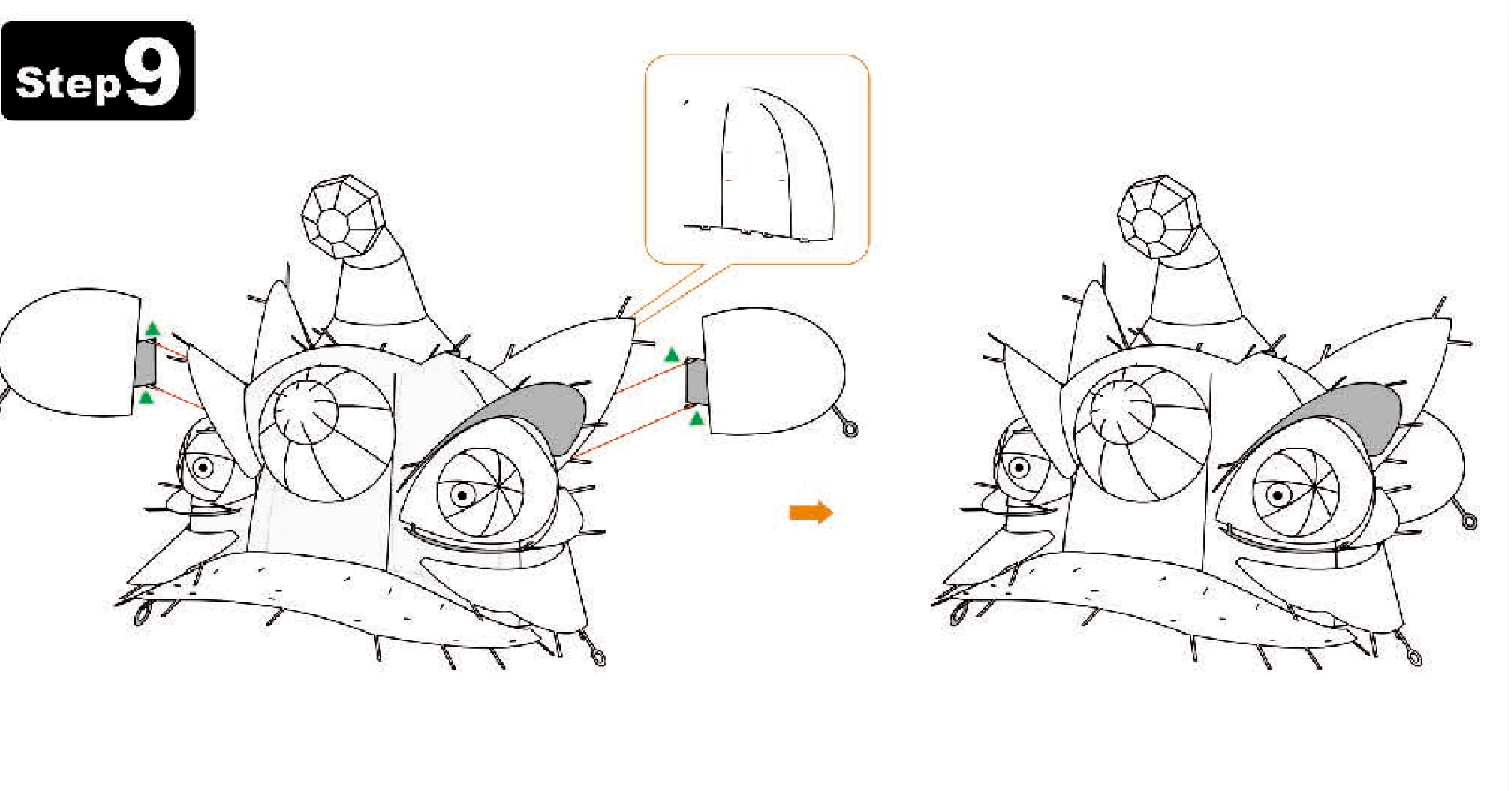
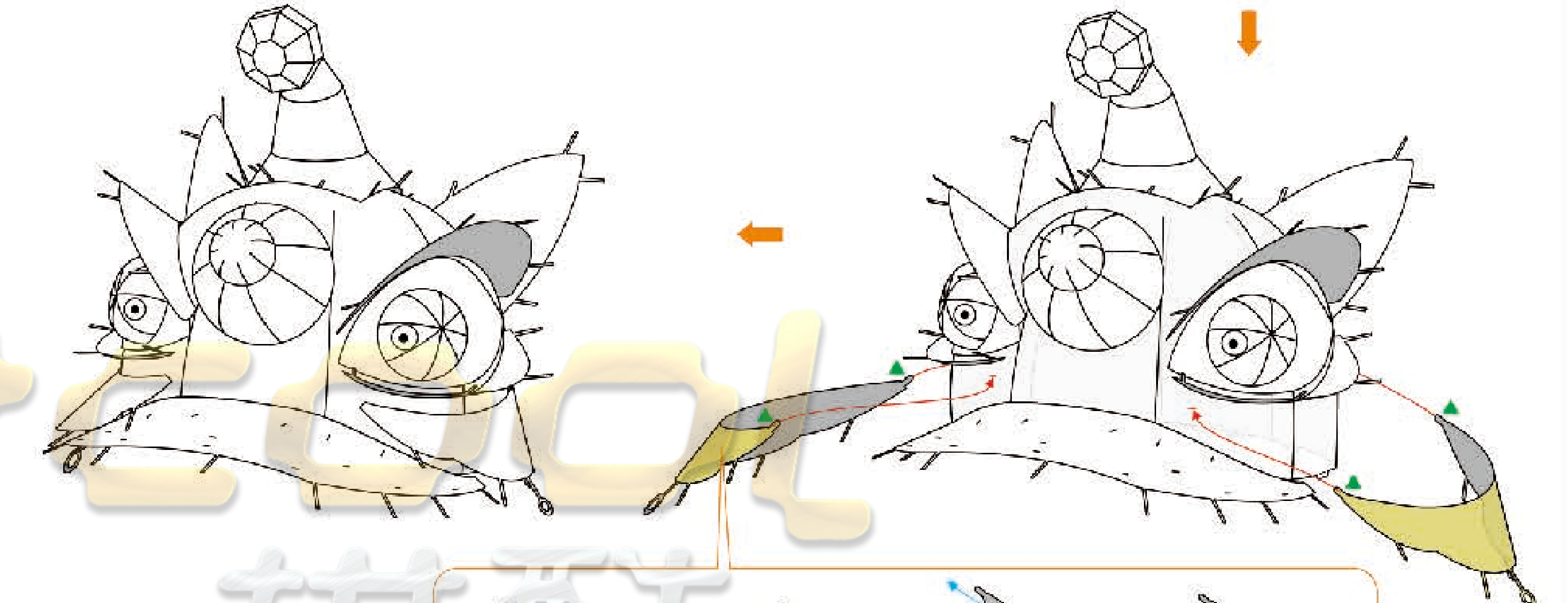
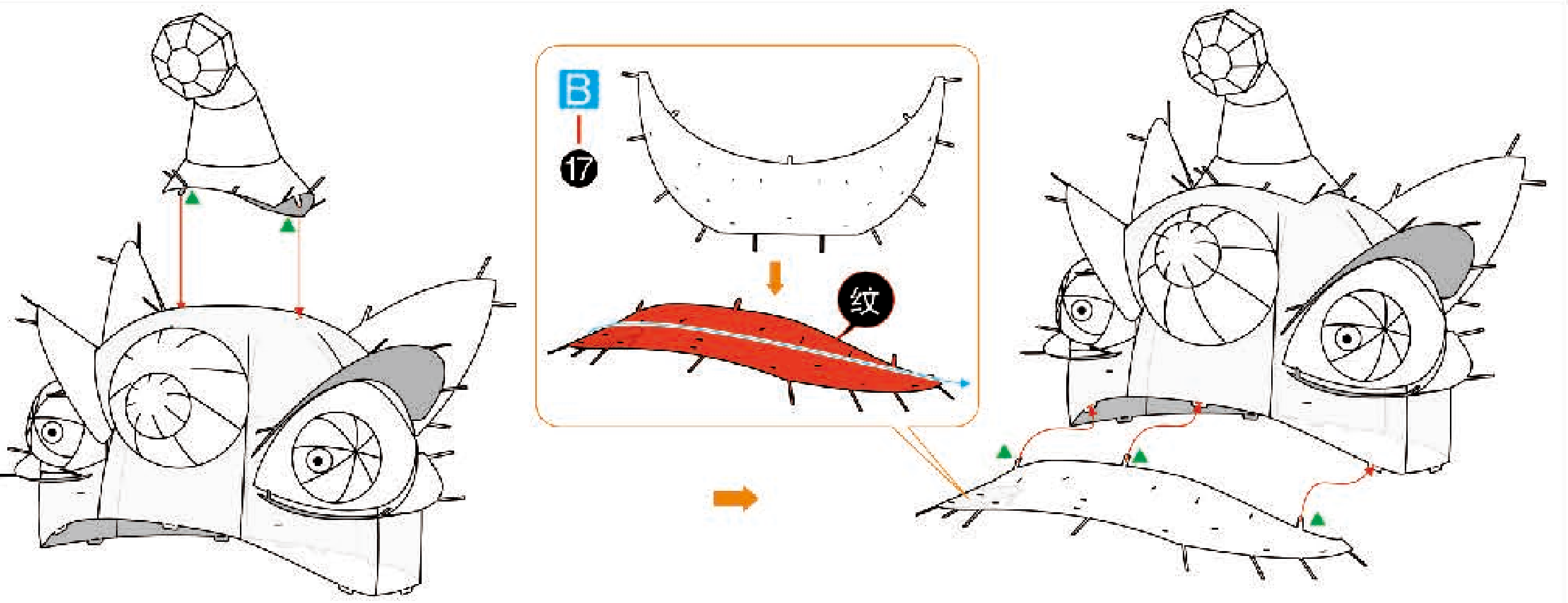
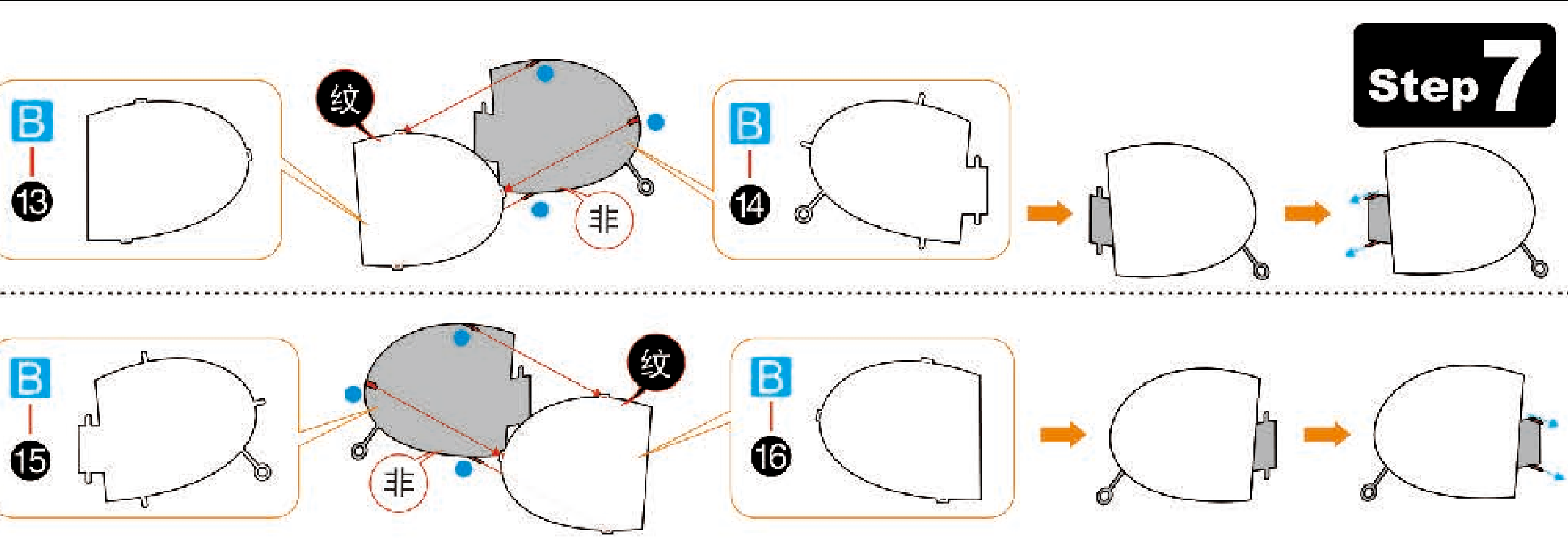
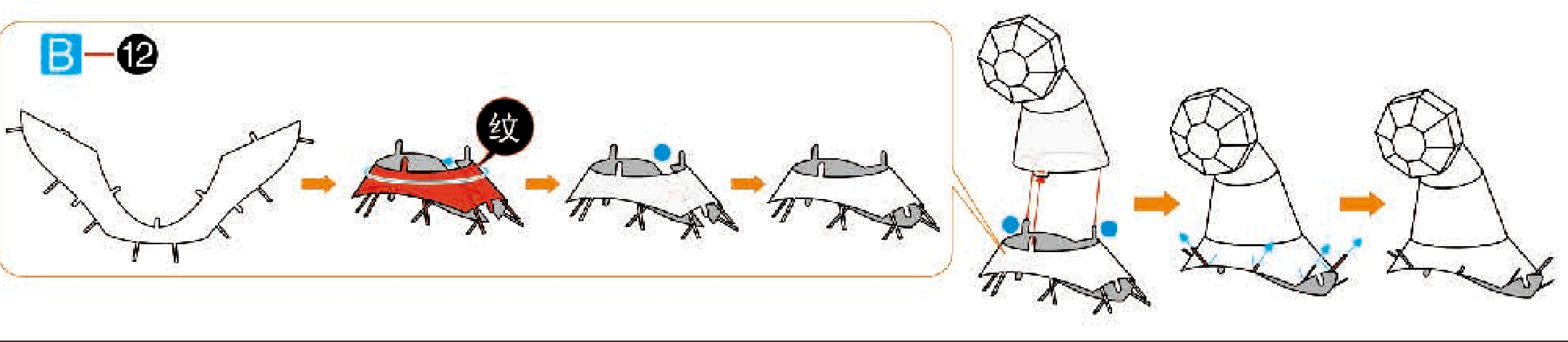
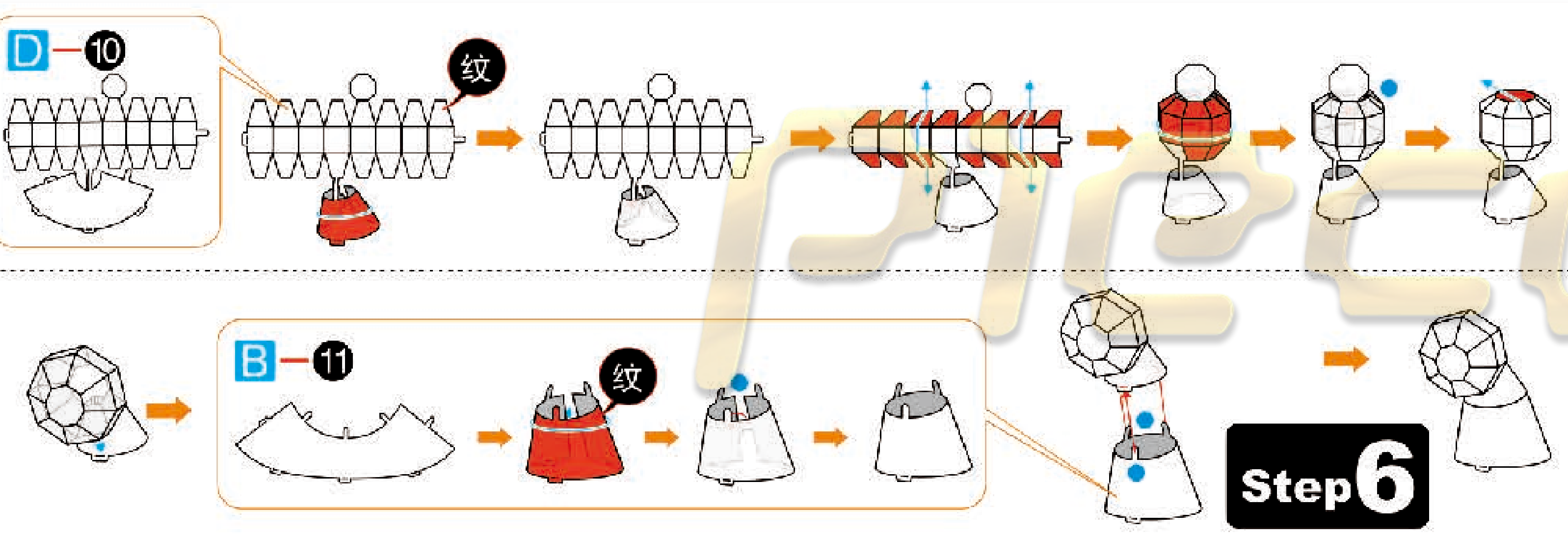
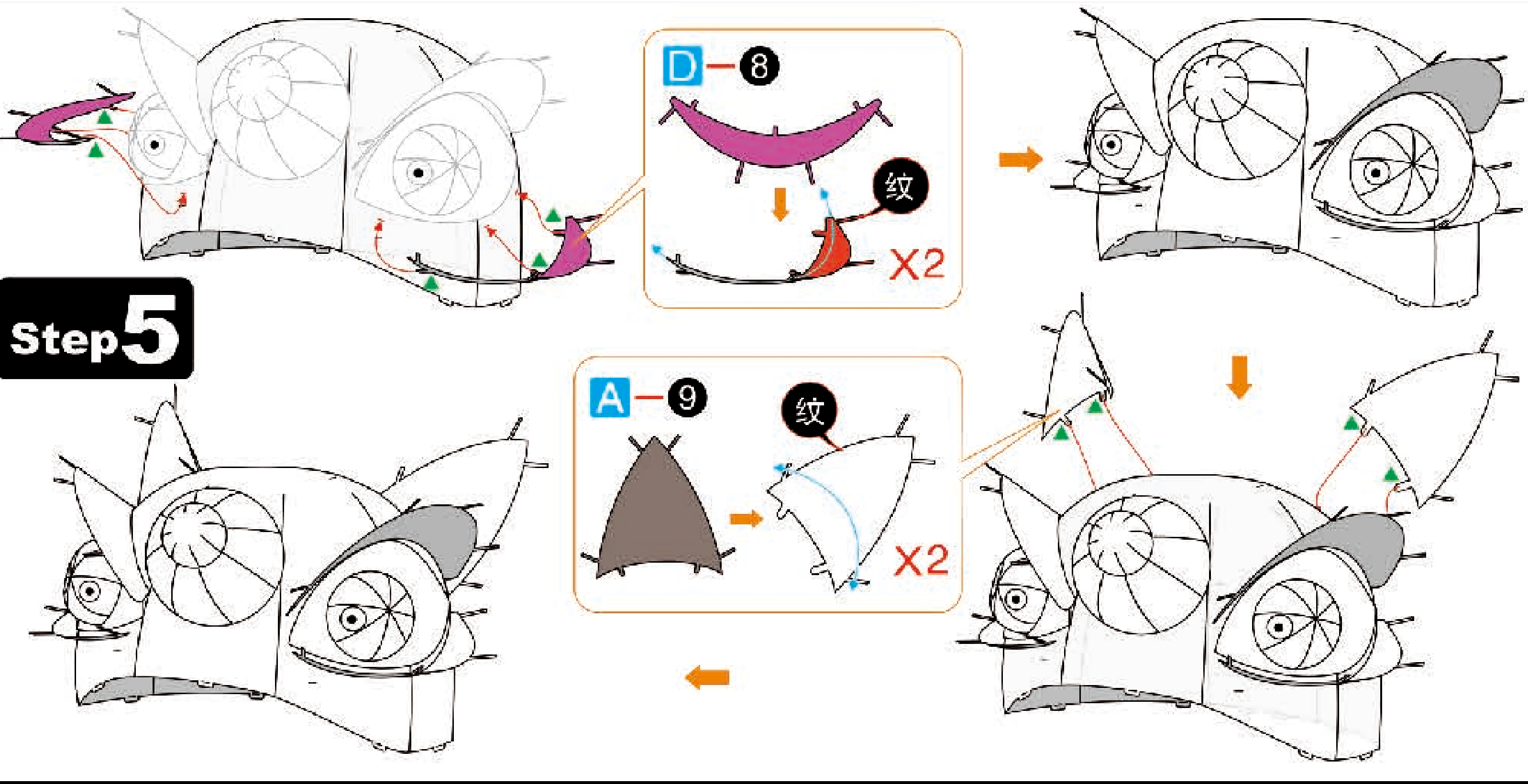
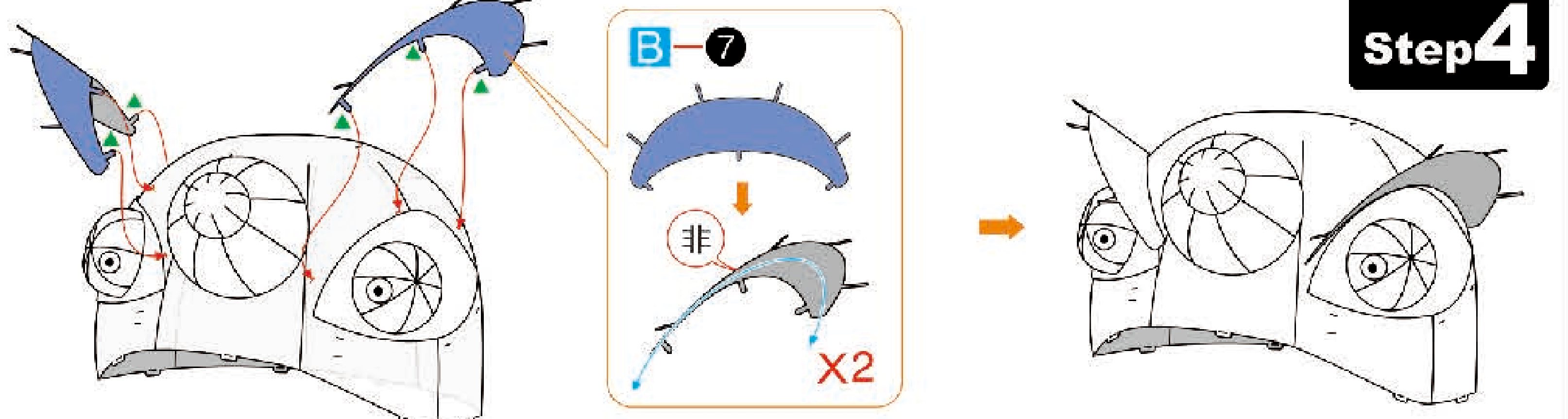

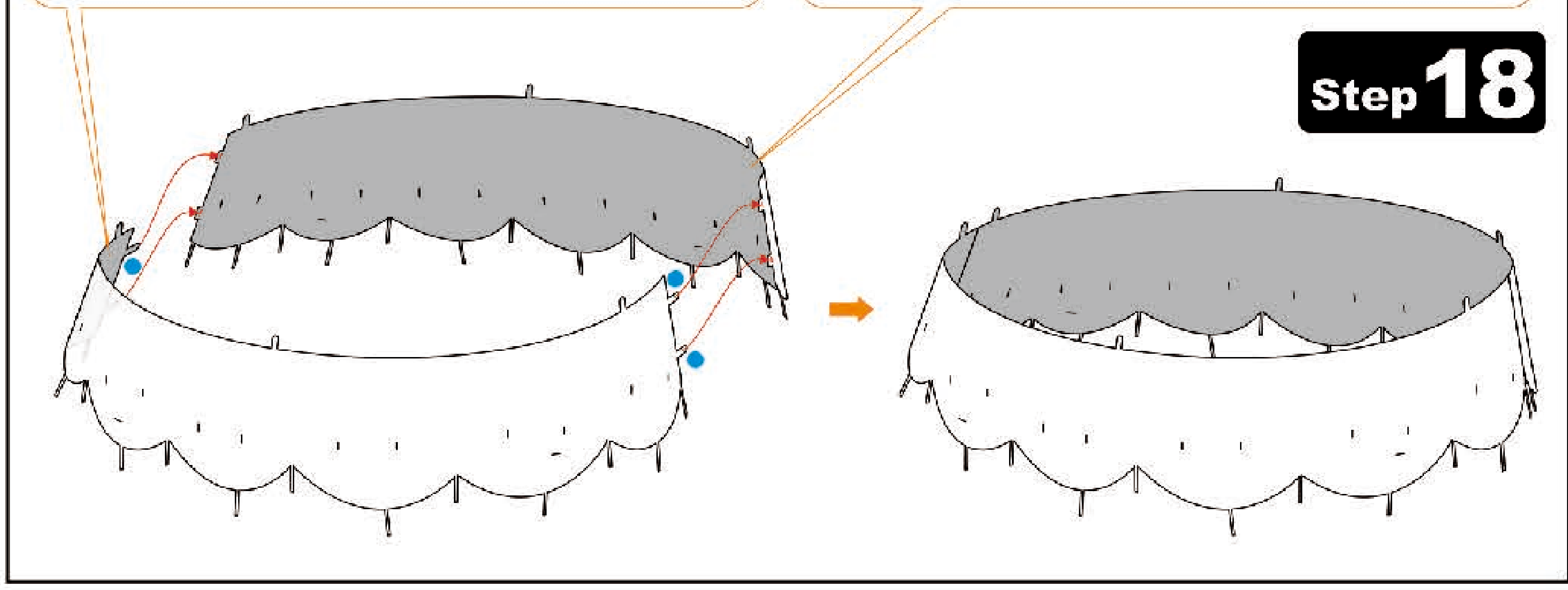
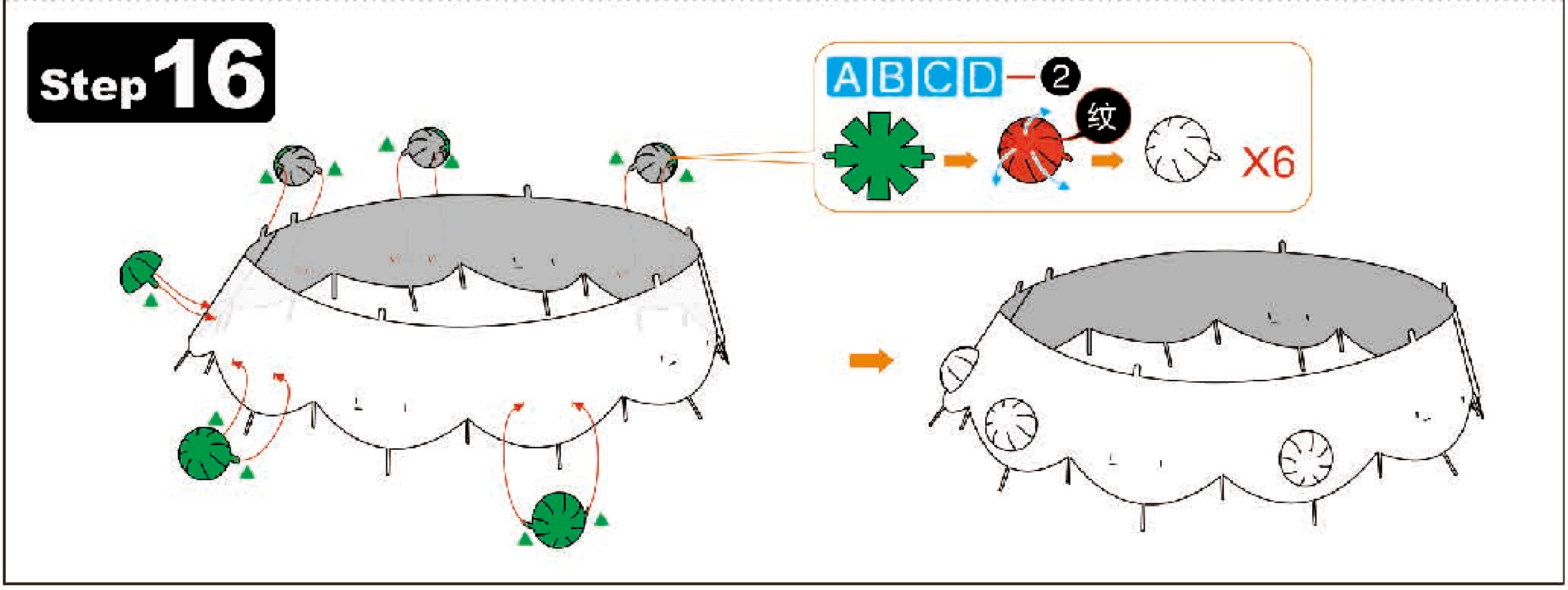
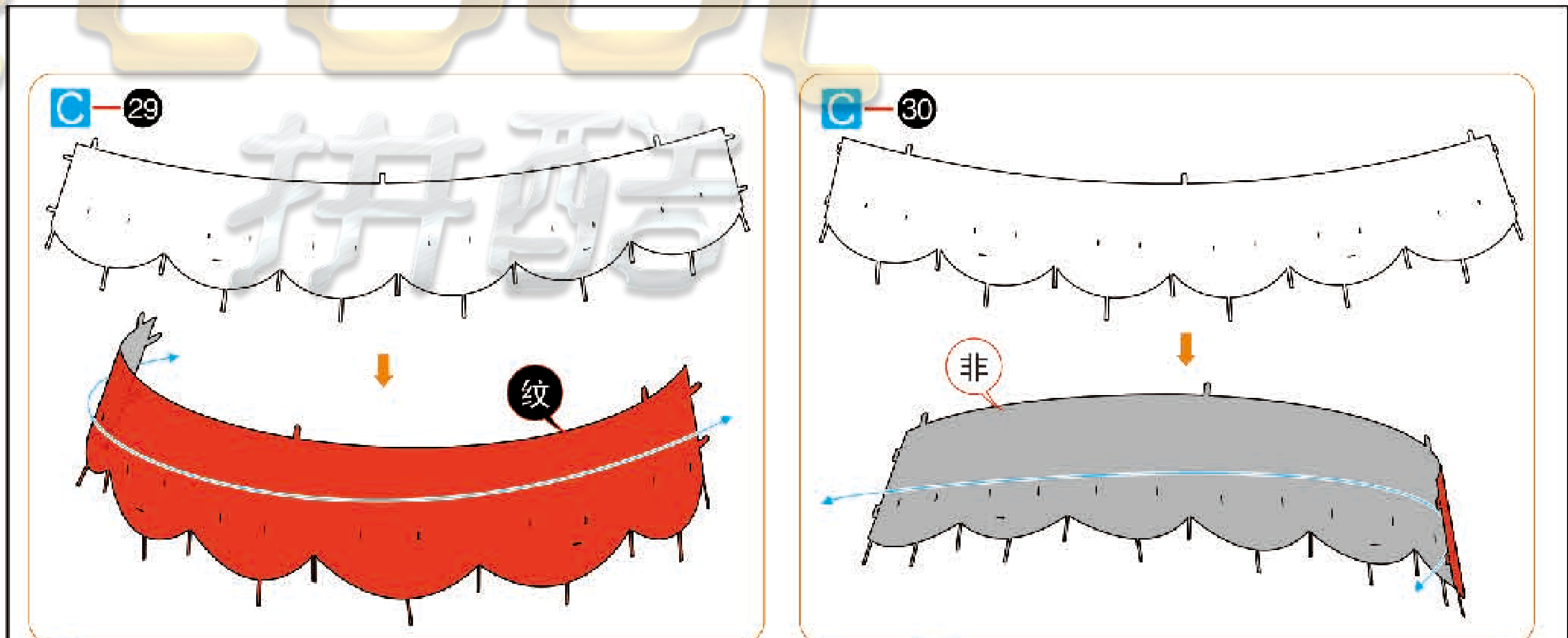
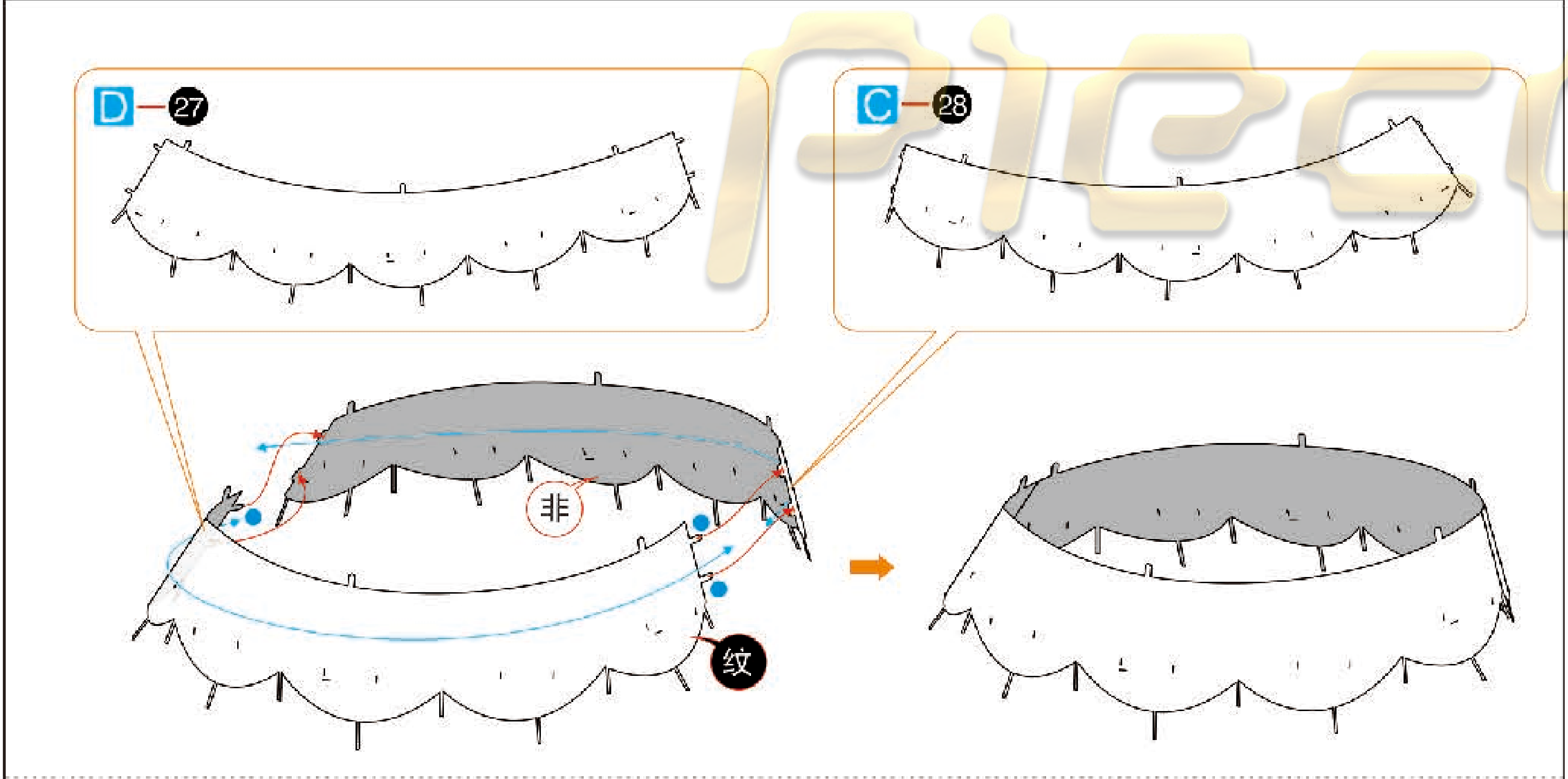
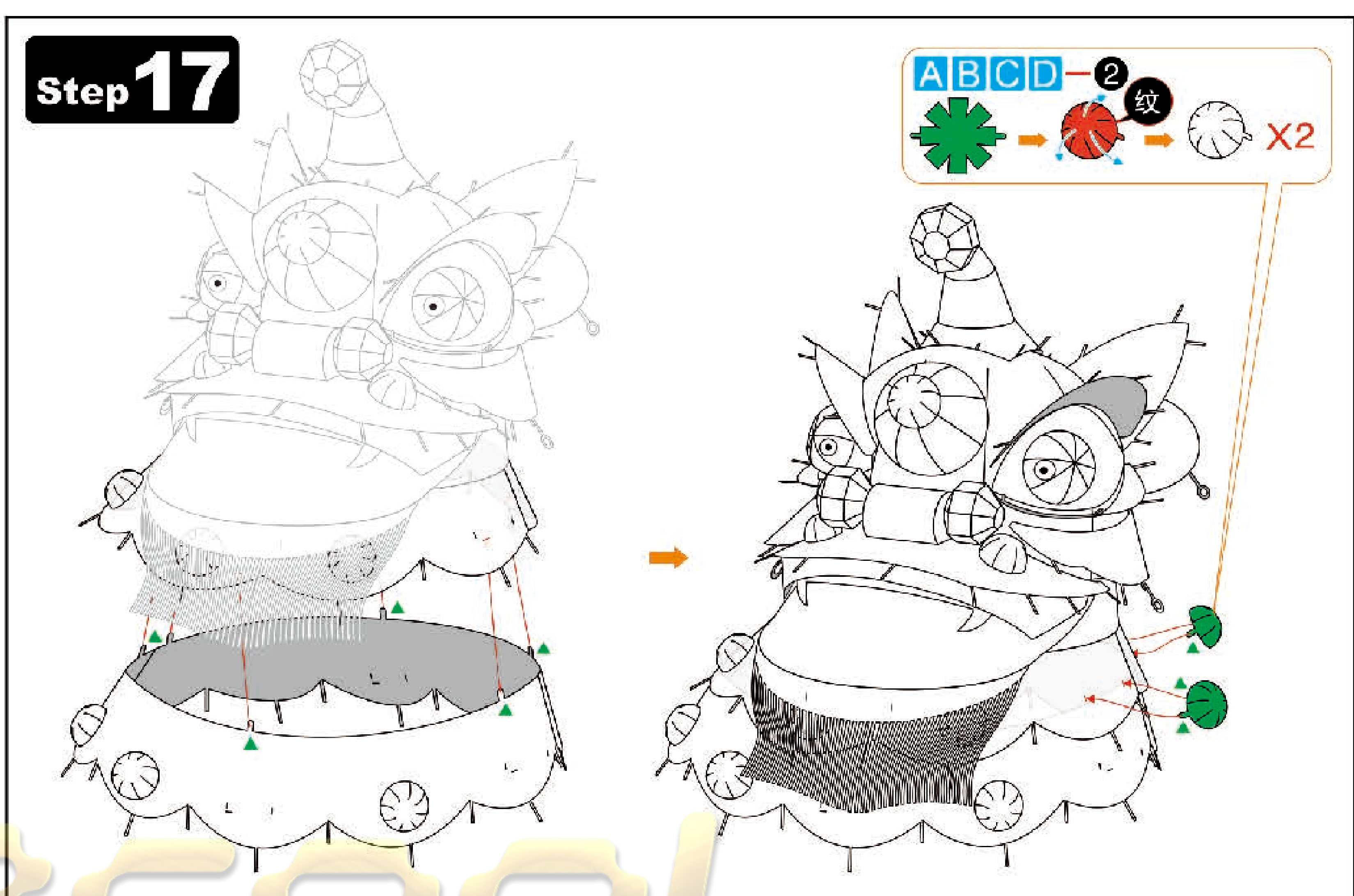
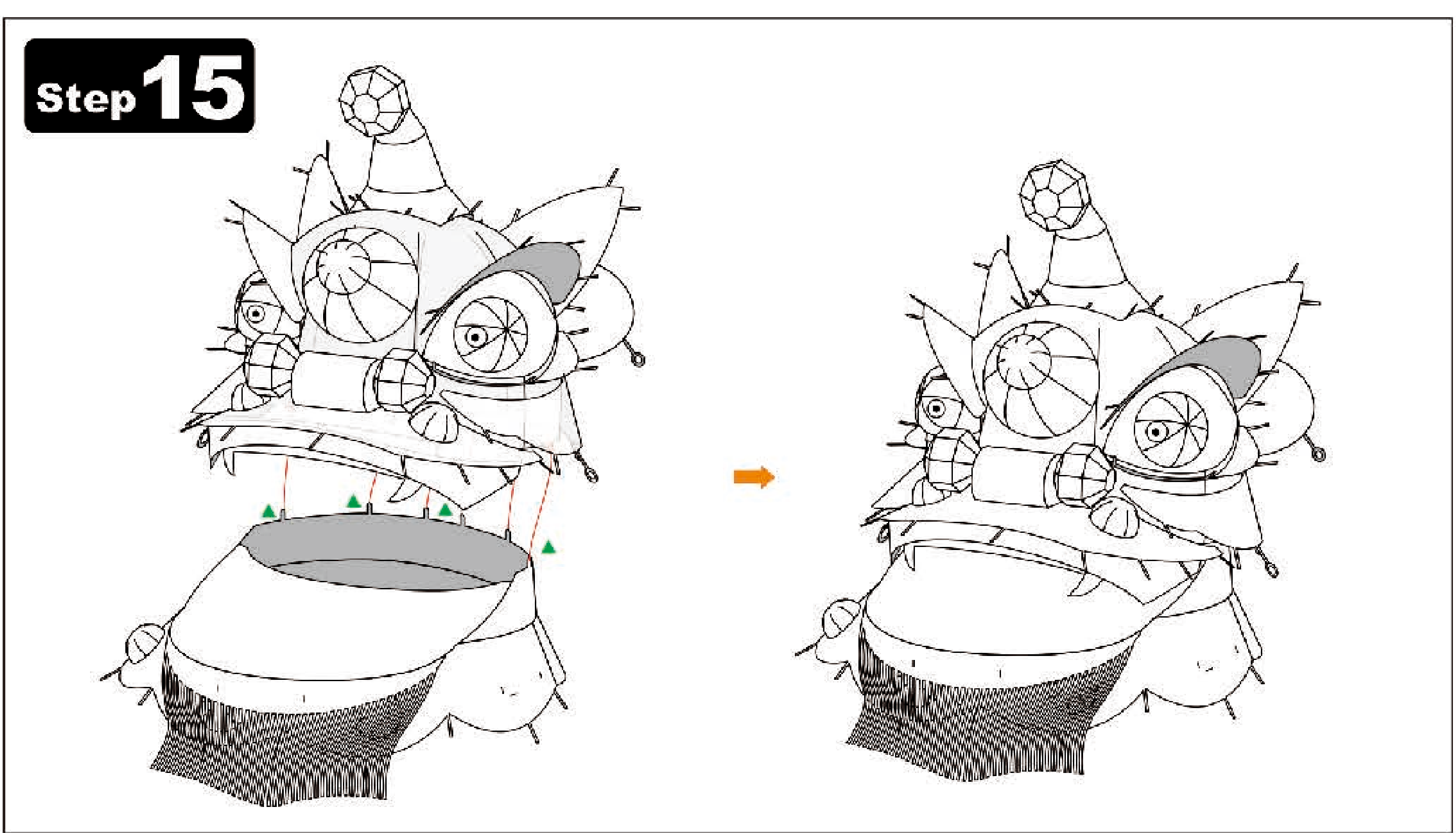
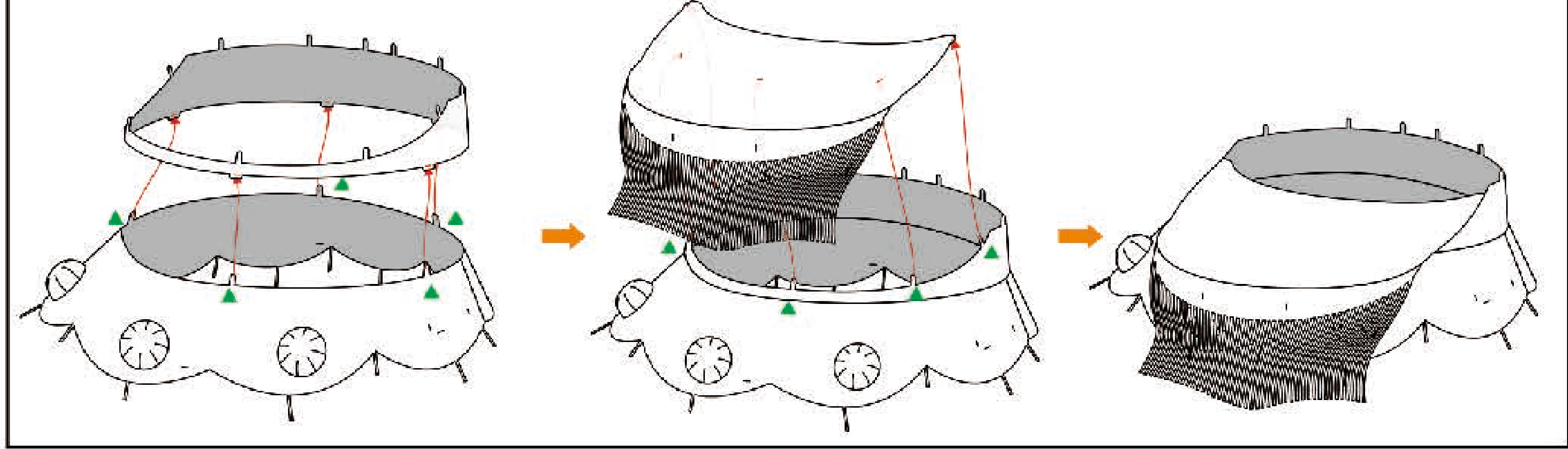
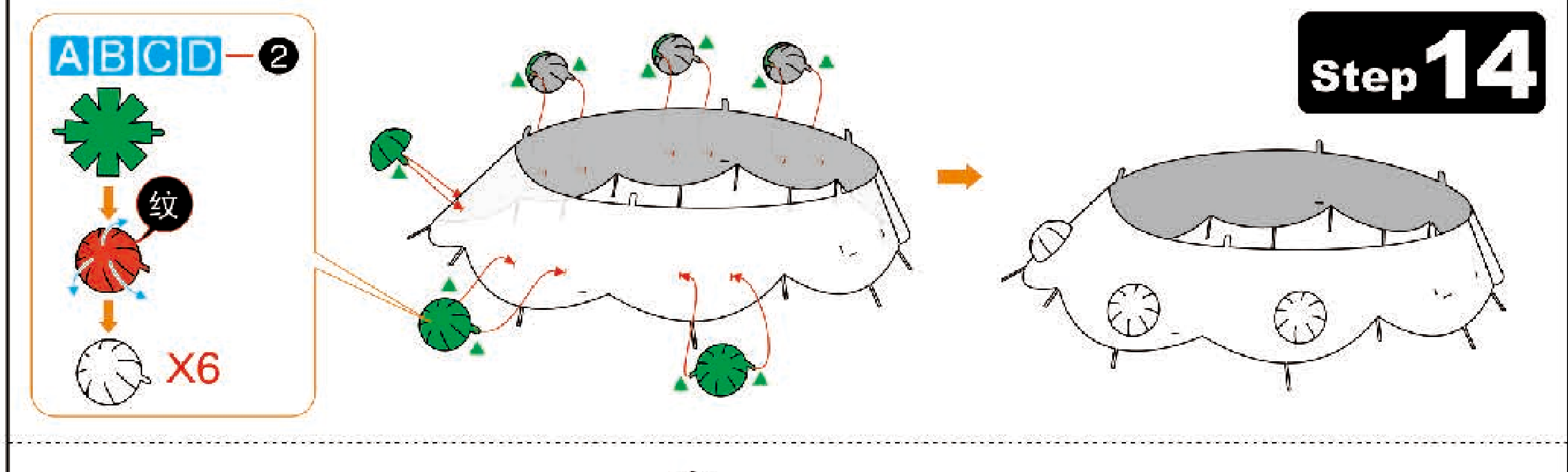
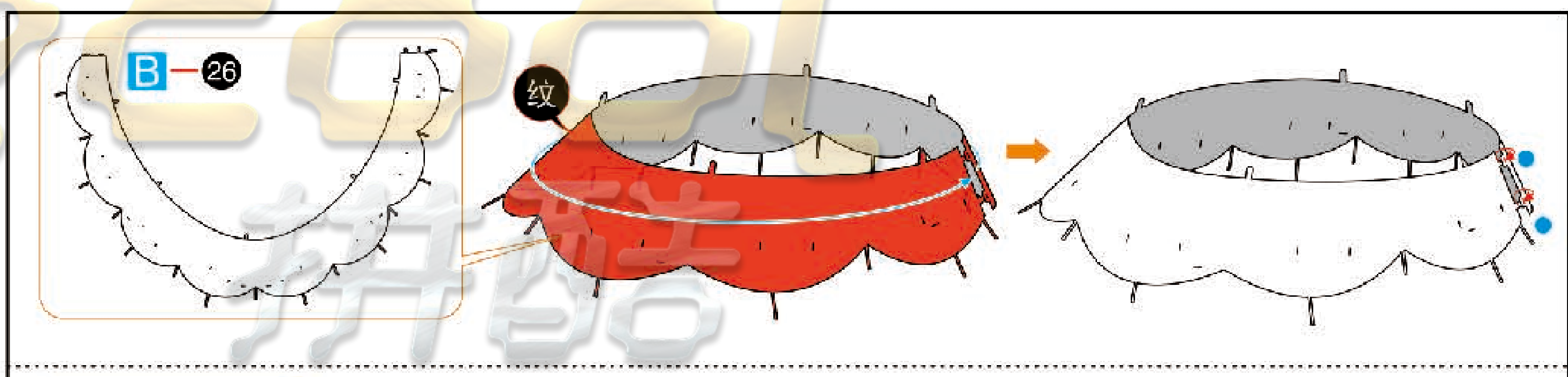
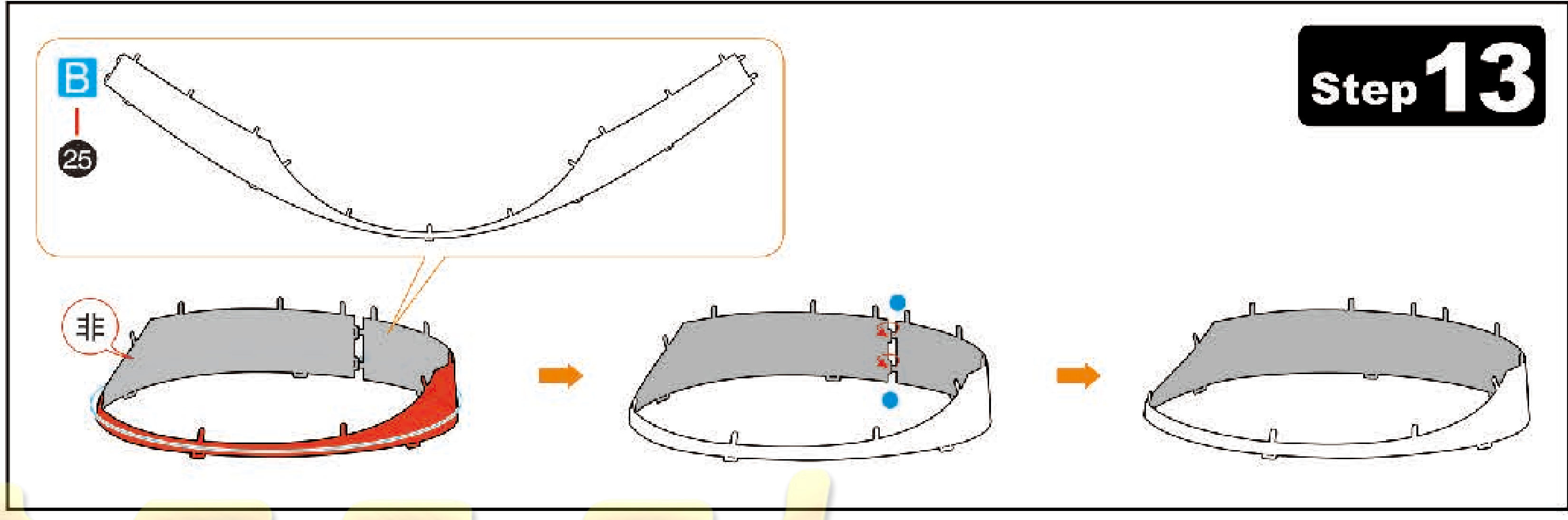
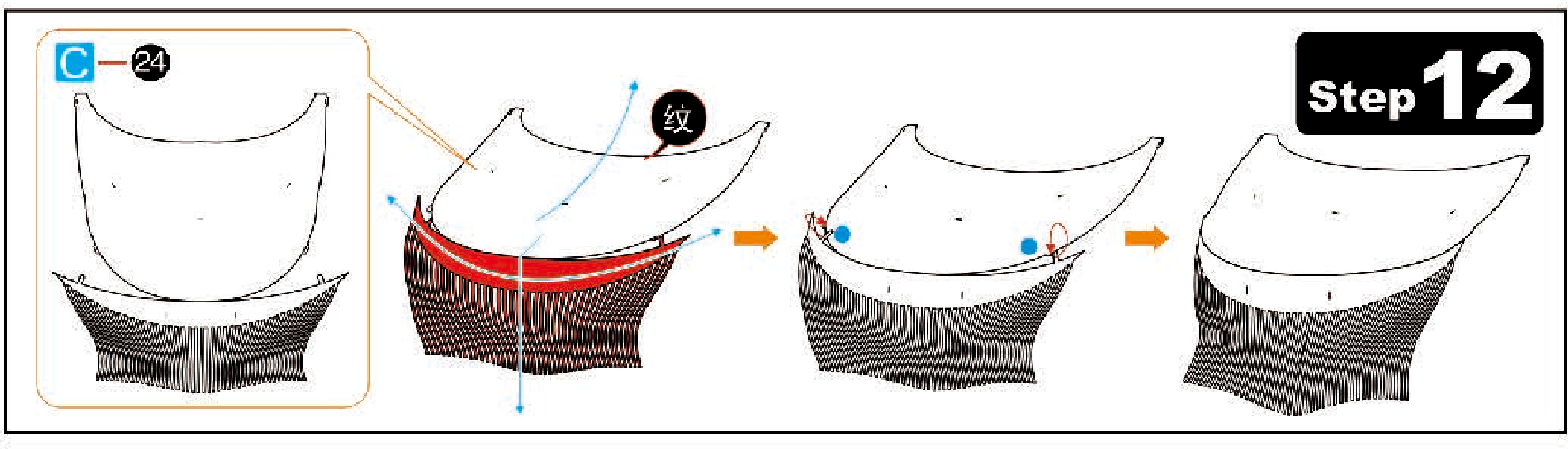
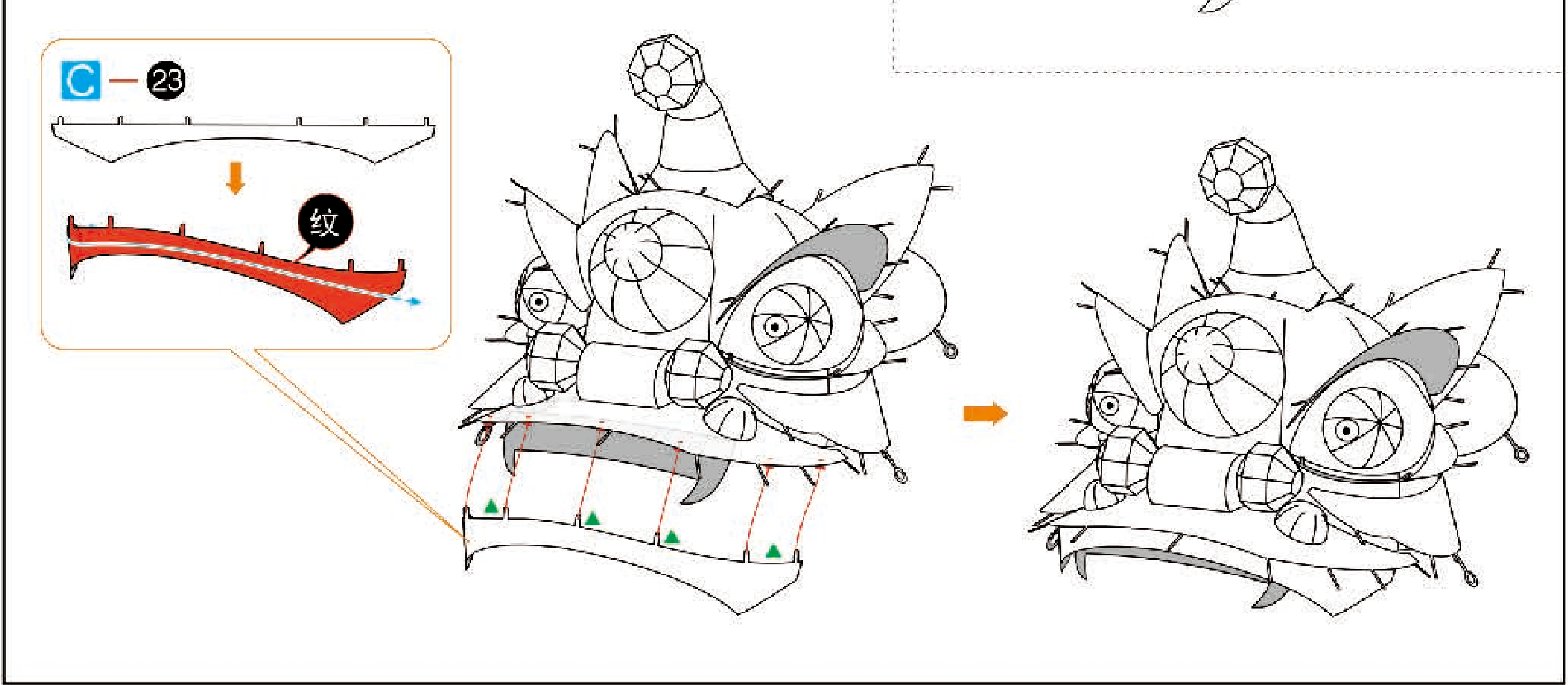
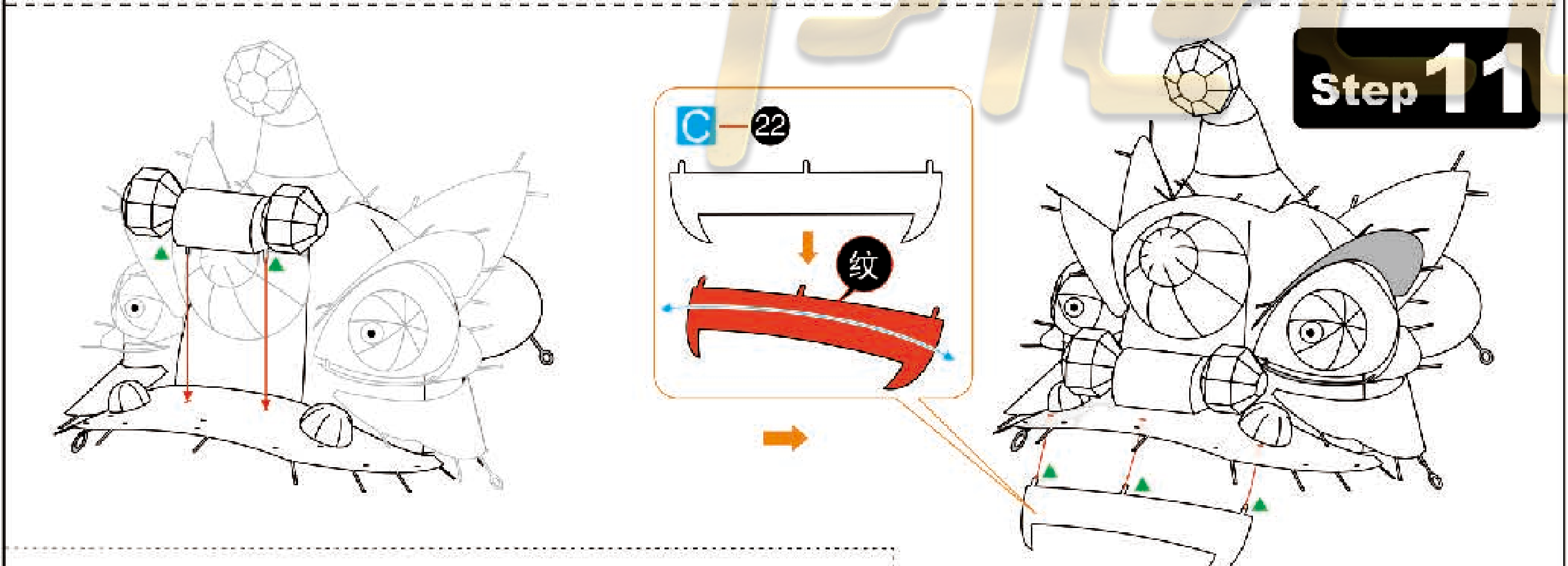
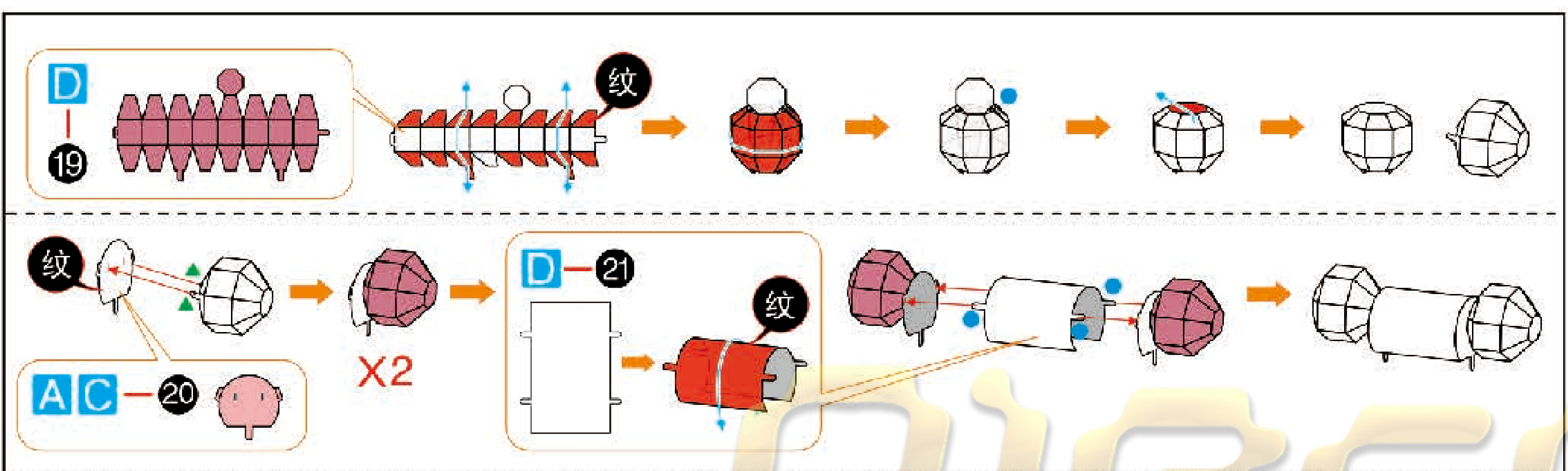
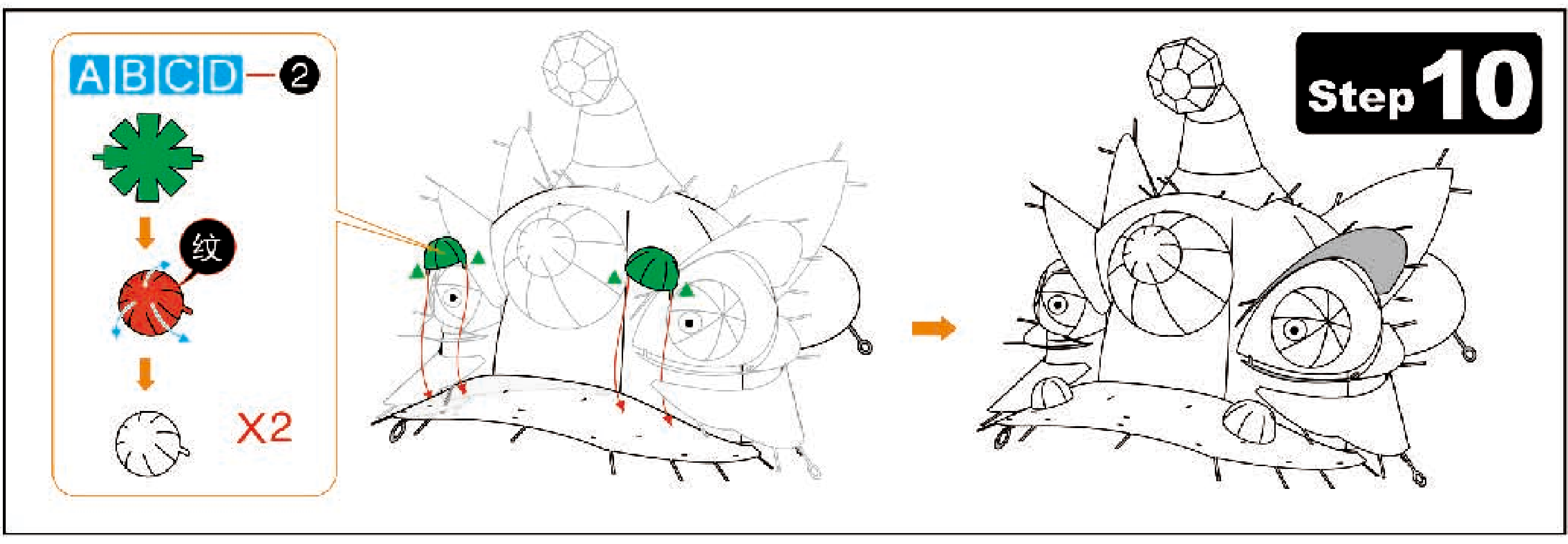

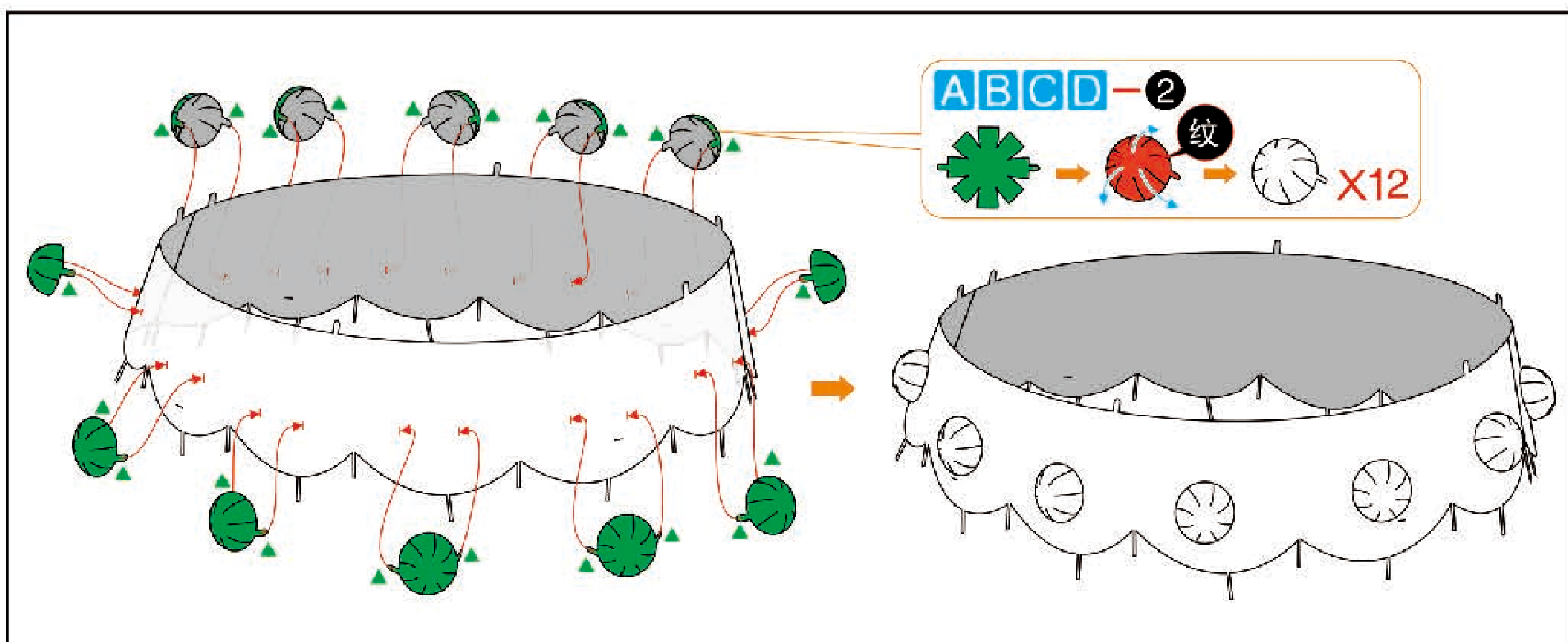

Step 19

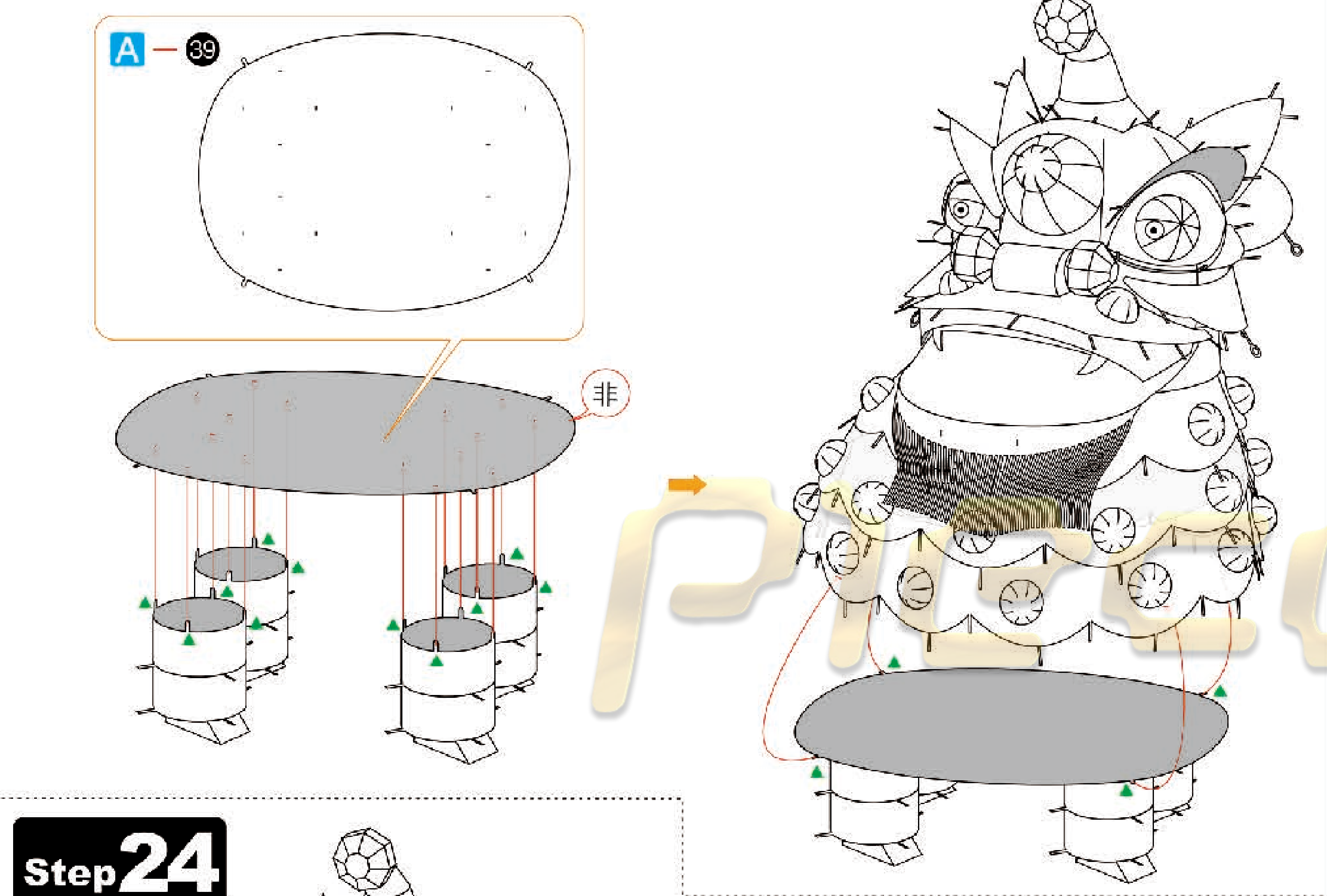
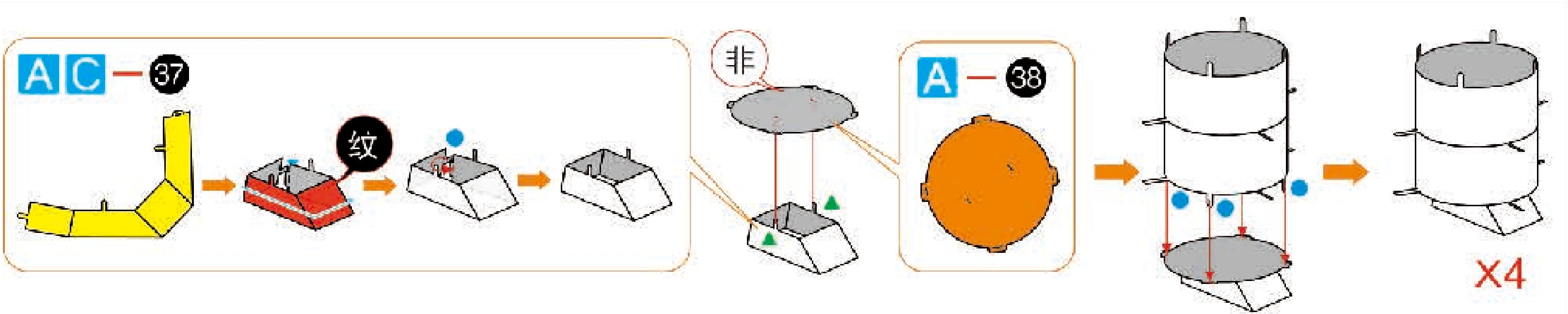
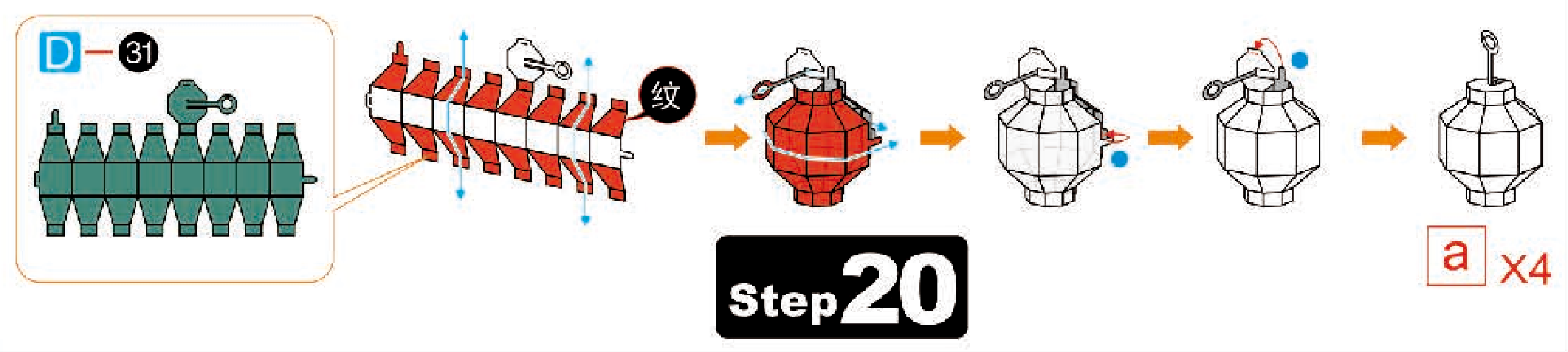
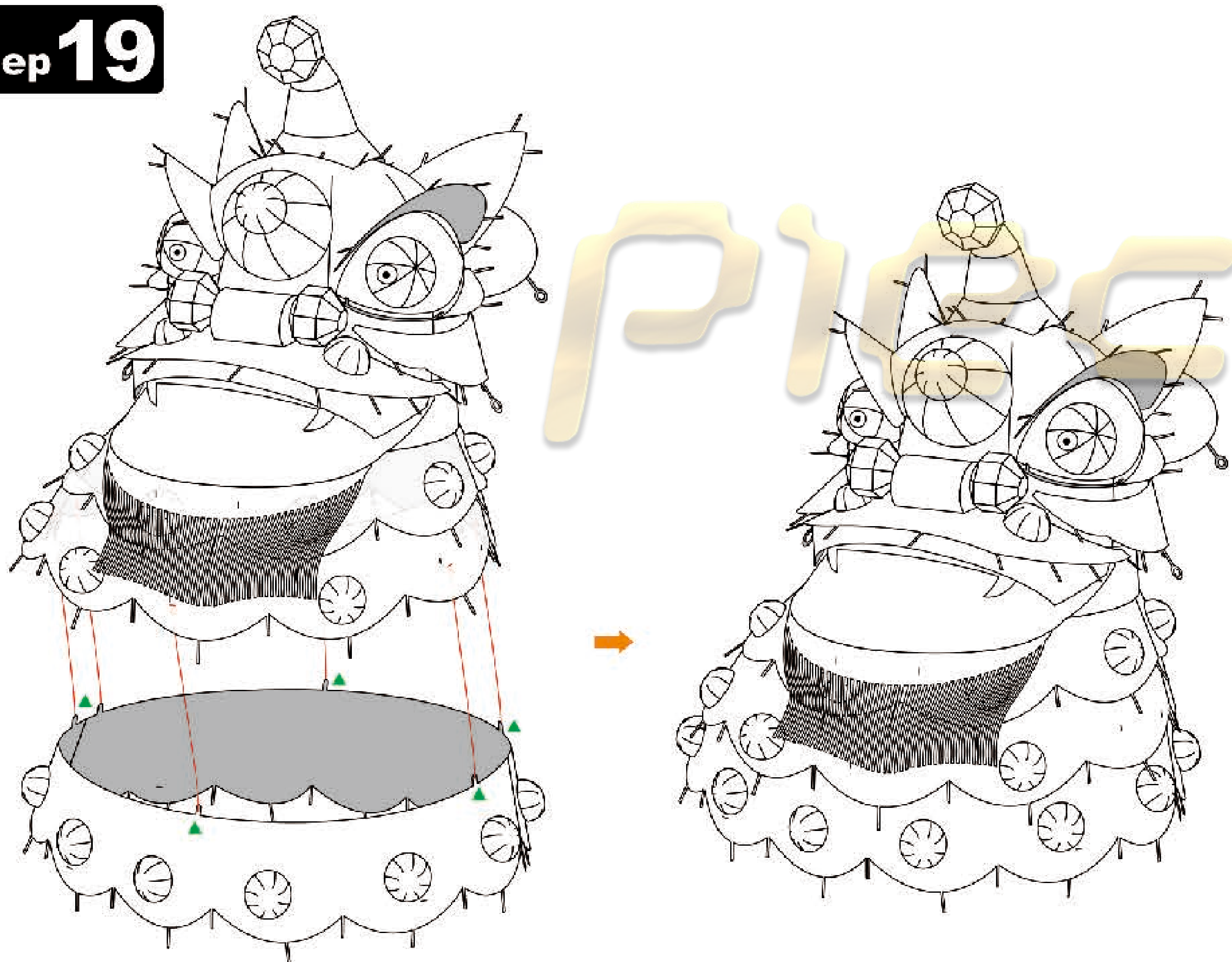

Step 24

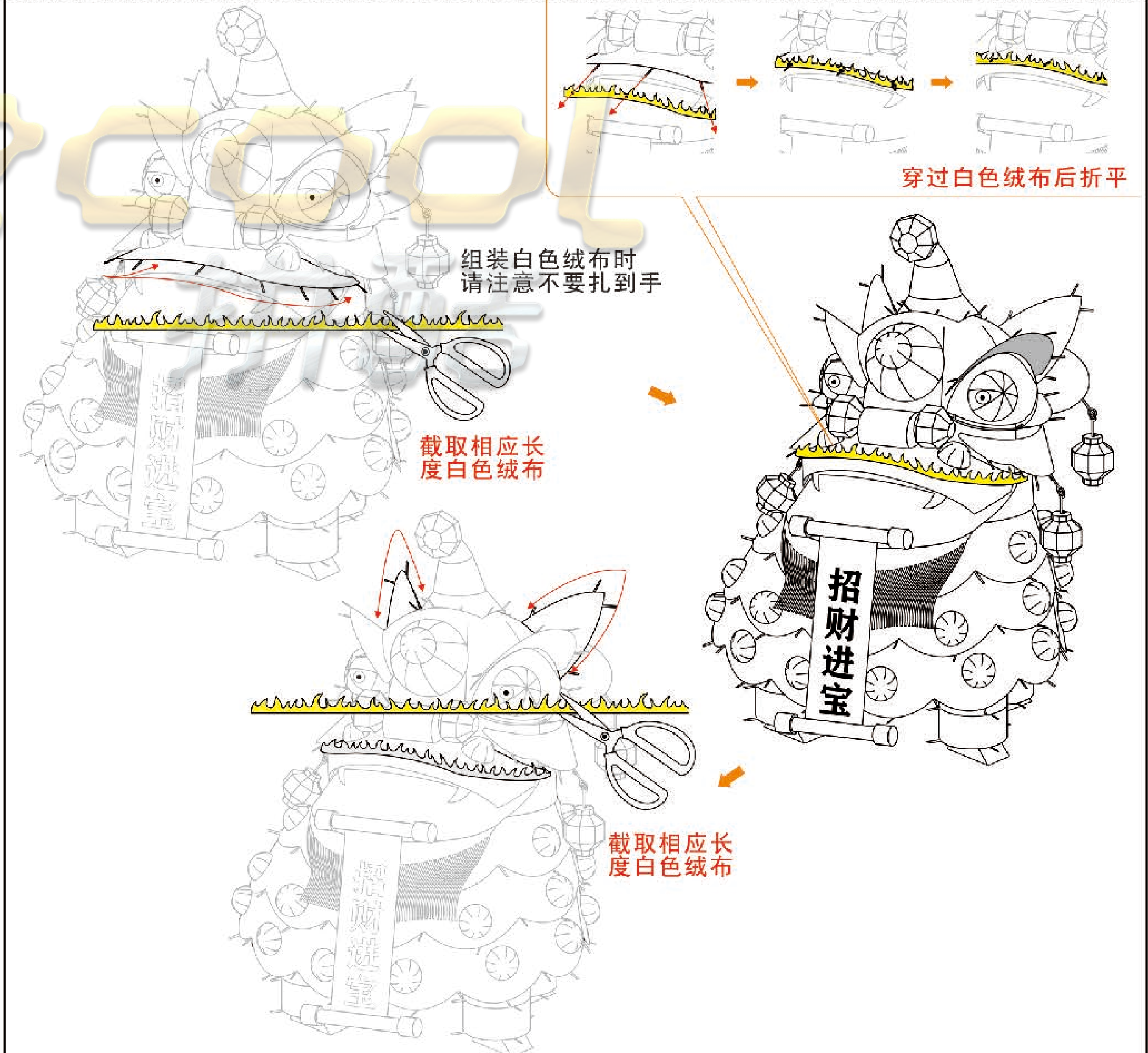
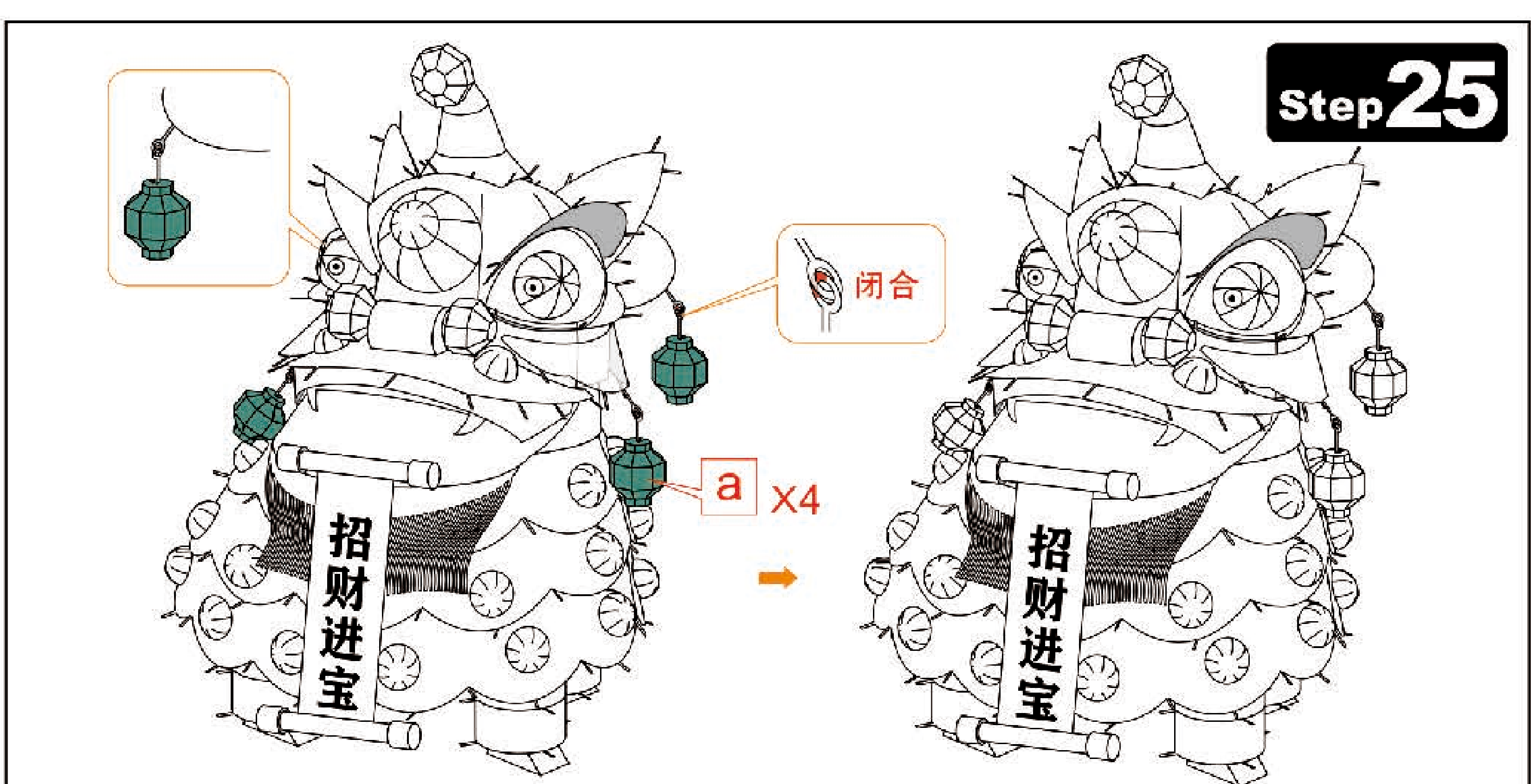
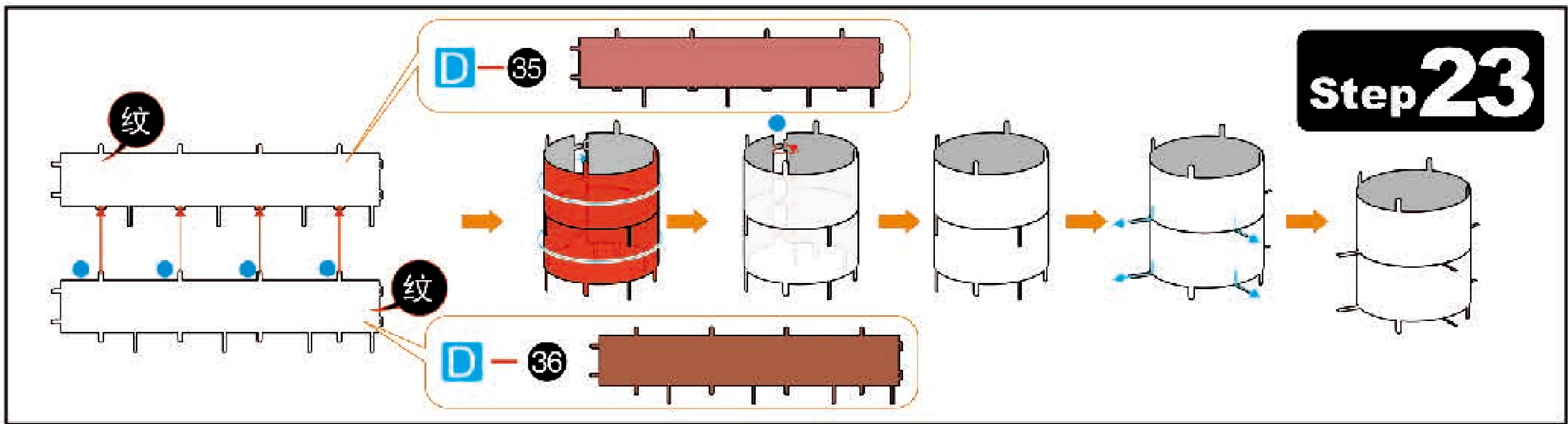
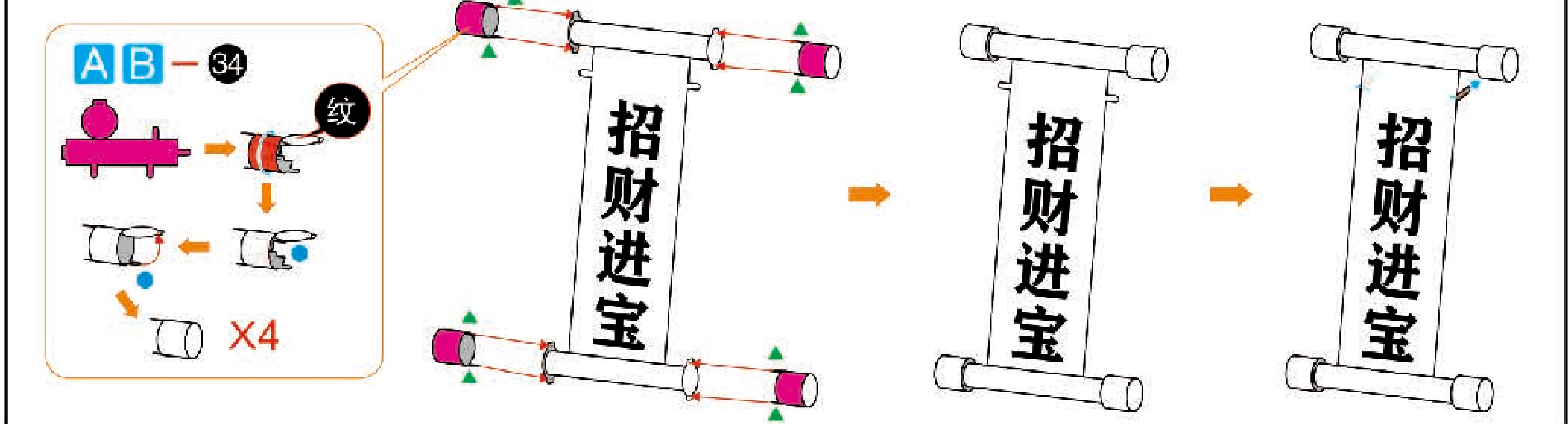
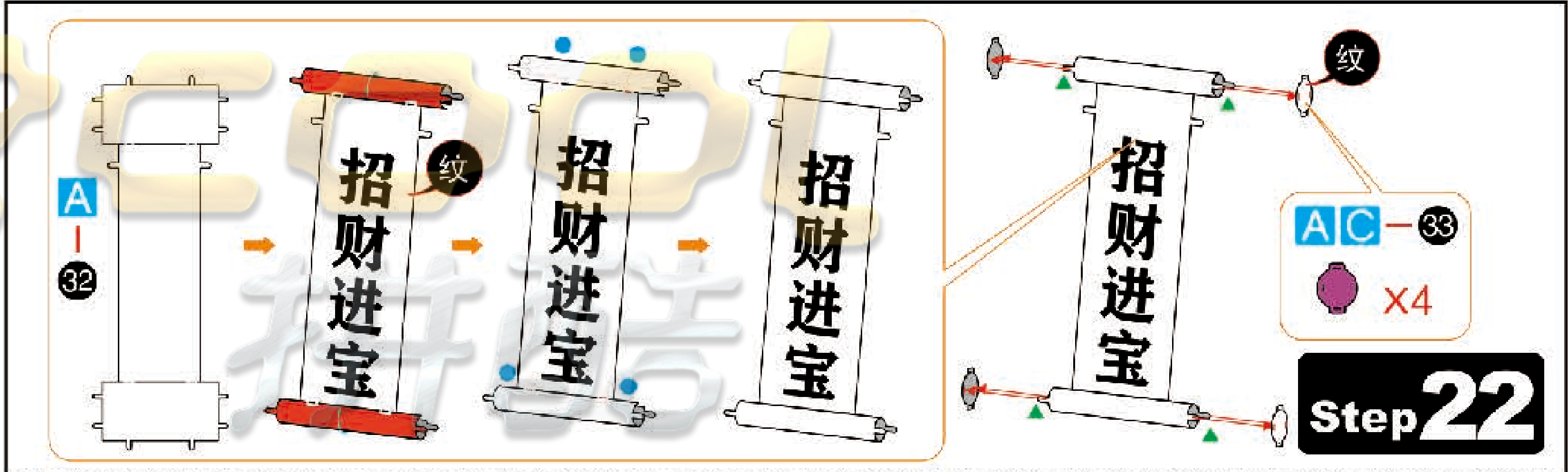
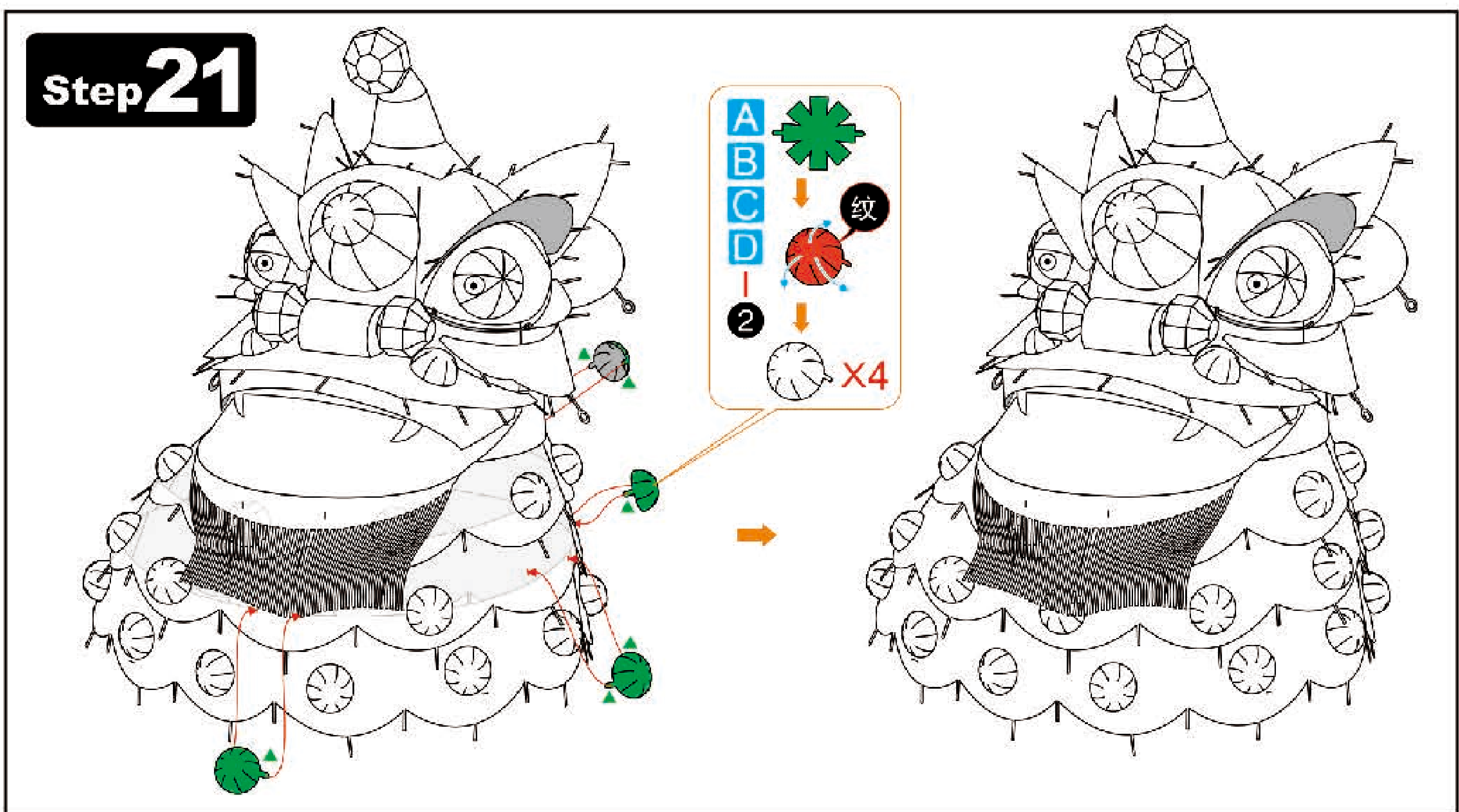
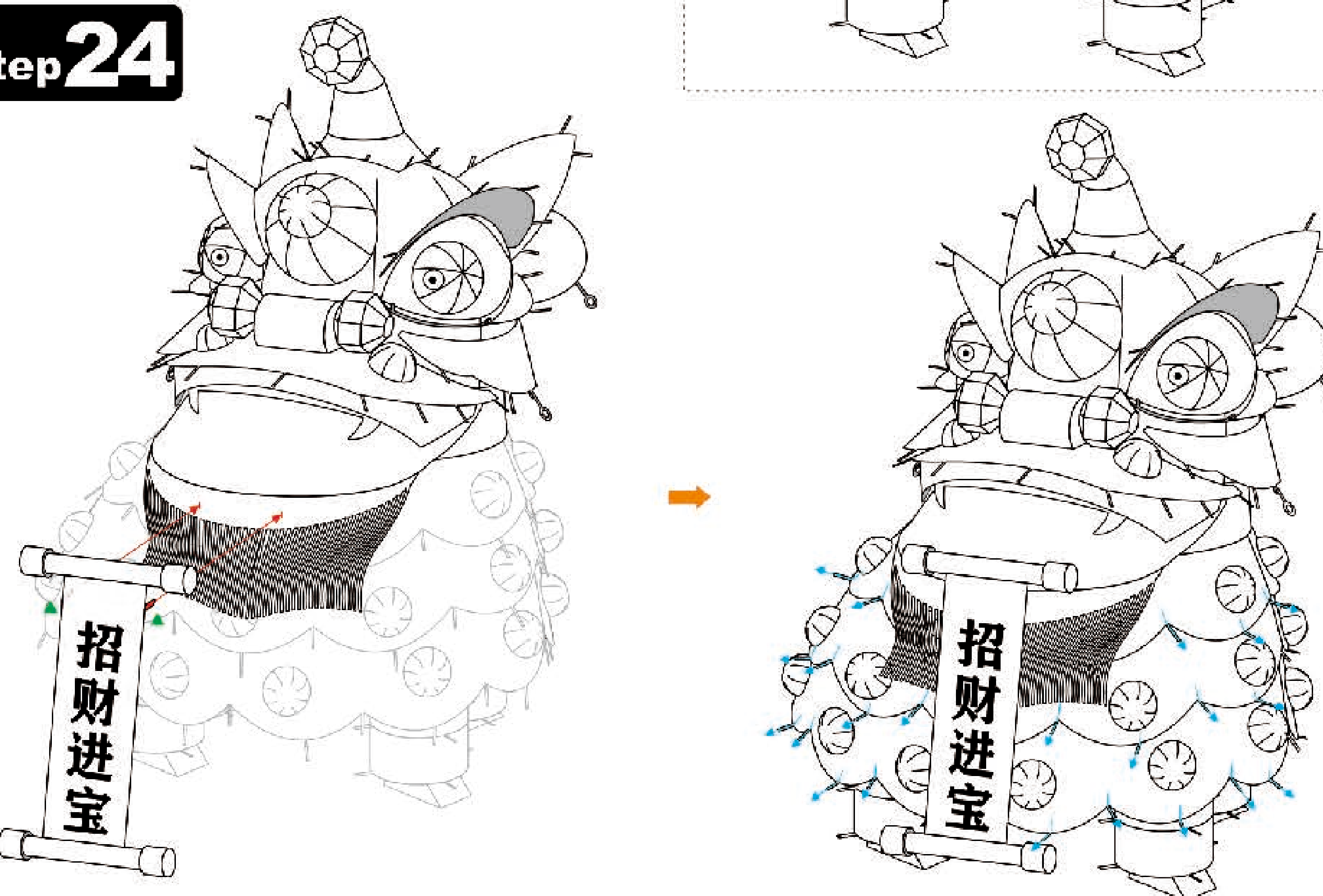

**Step 26**

截取相应长度白色绒布

穿过白色绒布后折平 X2

穿过白色绒布后折平

截取相应长度白色绒布

穿过白色绒布后折平 X2

穿过白色绒布后折平

穿过白色绒布后折平 X2

**Step 27**

穿过白色绒布后折平 X2

穿过白色绒布后折平

截取相应长度白色绒布

穿过白色绒布后折平 X2

穿过白色绒布后折平

截取相应长度白色绒布

穿过白色绒布后折平 X2

**Step 28**

穿过白色绒布后折平

穿过白色绒布后折平

截取相应长度白色绒布

穿过白色绒布后折平

穿过白色绒布后折平

截取相应长度白色绒布

穿过白色绒布后折平

**Step 29**

穿过白色绒布后折平

穿过白色绒布后折平

截取相应长度白色绒布

穿过白色绒布后折平

穿过白色绒布后折平

截取相应长度白色绒布

穿过白色绒布后折平 X4

13 14  
15 16

Piececool  
拼酷

[www.Piececool.com](http://www.Piececool.com)

© WIST PLASTIC & METAL TECHNOLOGY LIMITED. ALL RIGHTS RESERVED.