

**BISMARCK BATTLESHIP
HP084**

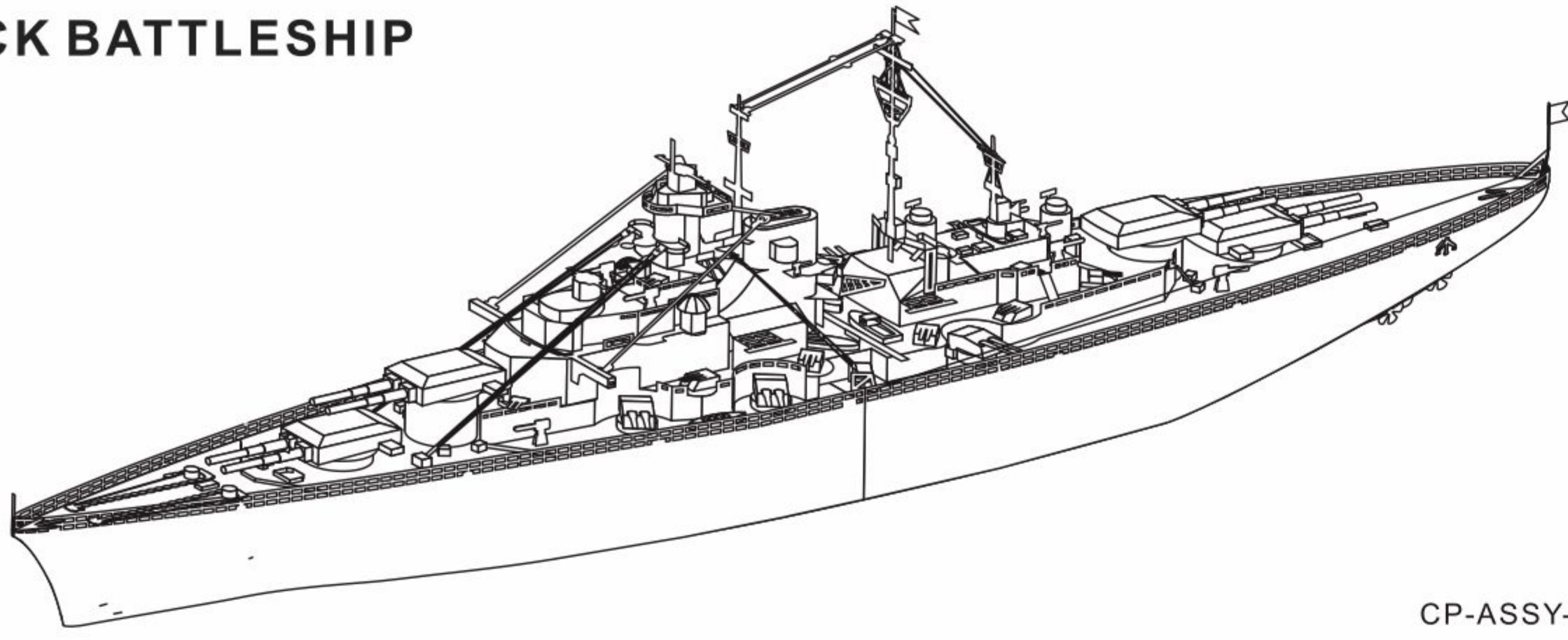

CP-ASSY-HP084#-A1-20190831

Installation Reminder

⚠ Please handle the metal trim carefully to prevent scratches.

● Insert the hole, bending tab with angle 90°
▲ Insert the hole, twisting tab with angle 90°

Identify the parts

	Insert tab
	Fold line
	Insert hole

Curling the yellow part
E Engraved / Color side
NE Non-engraved / Silver side
! Attention Point
 Keep the parts symmetrical

Metal Sheet

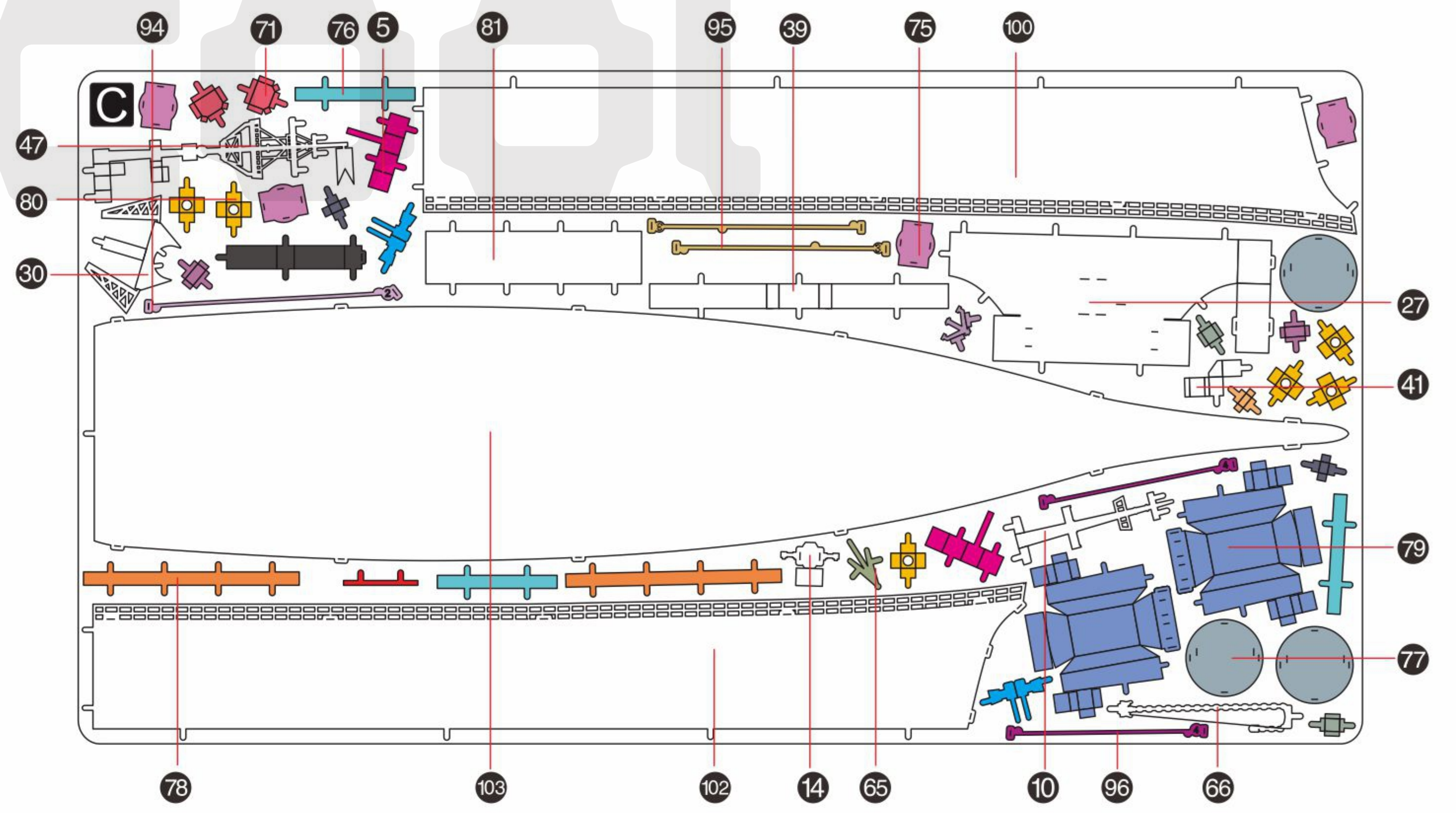
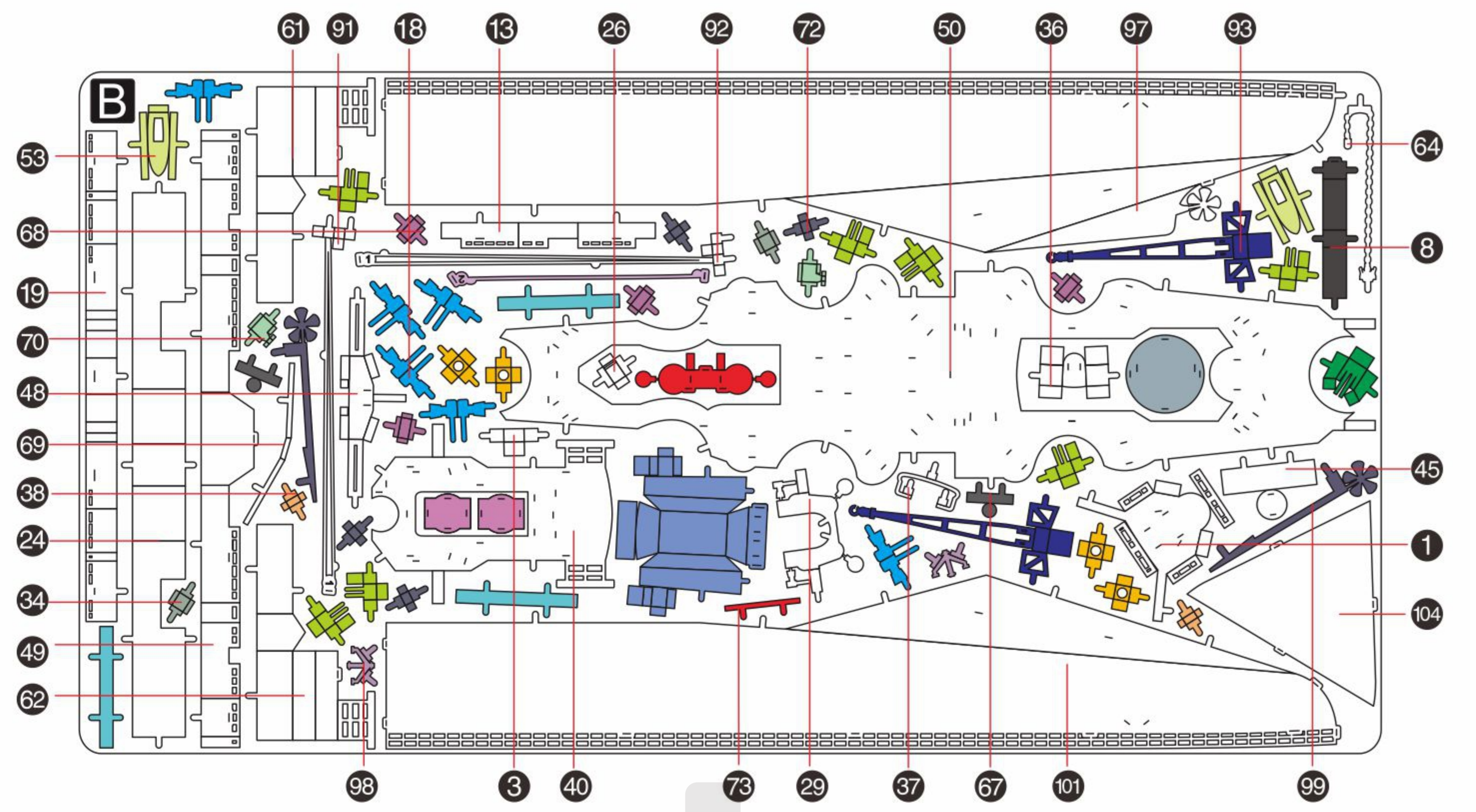
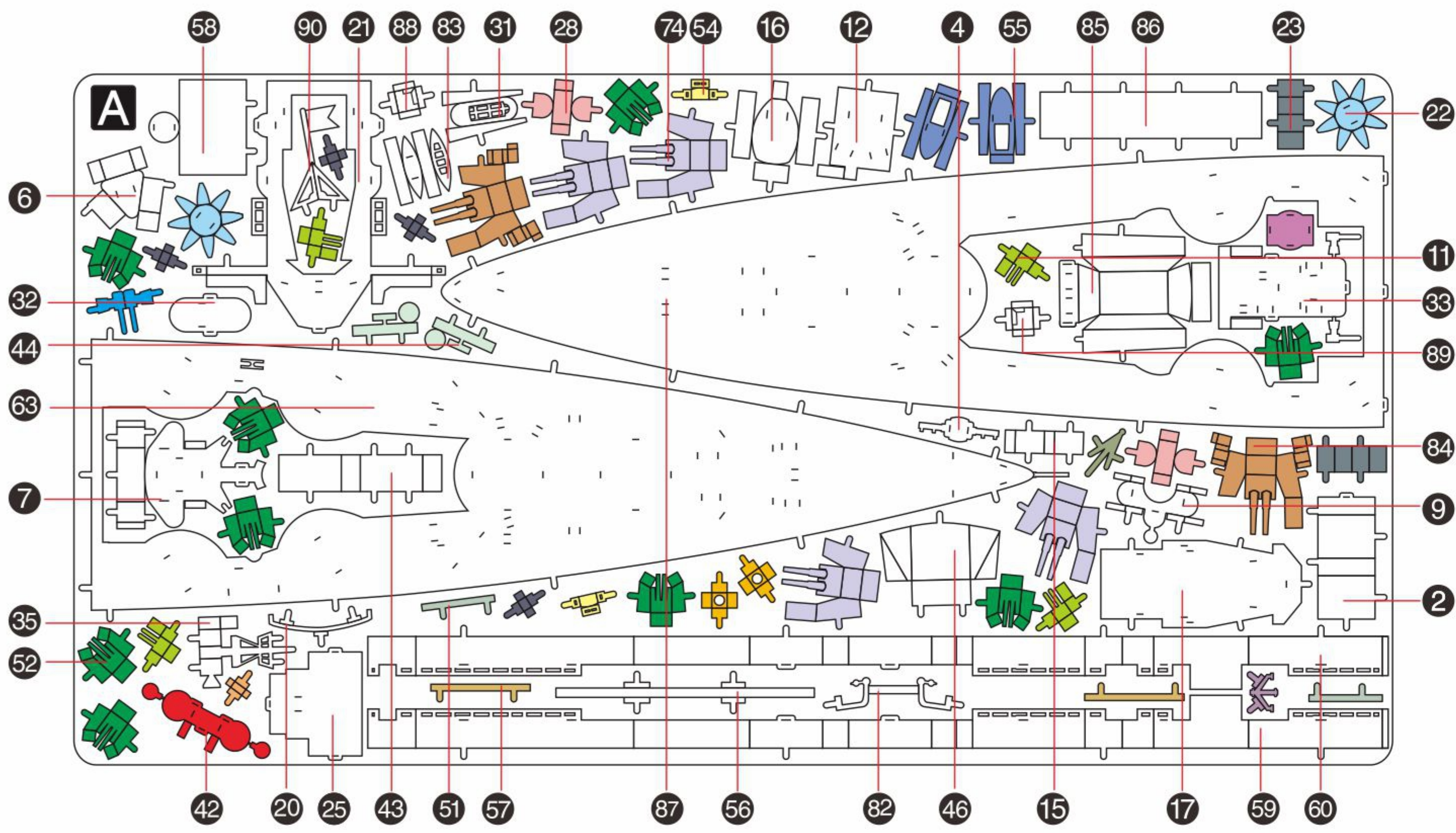

Assembly Flow Chart

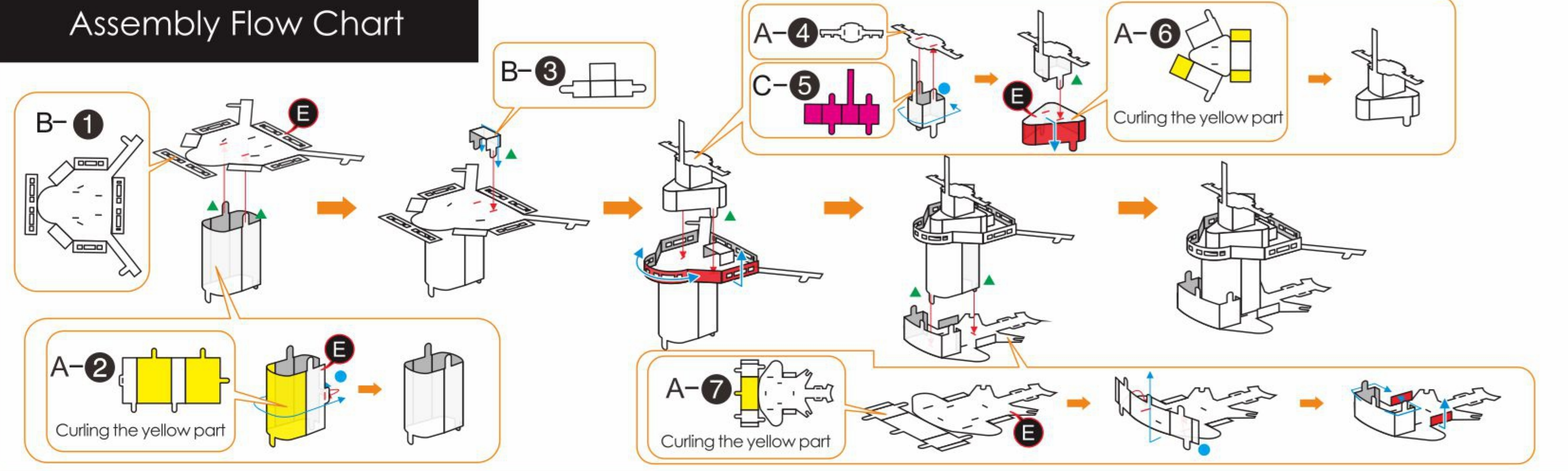

1 2
3 4

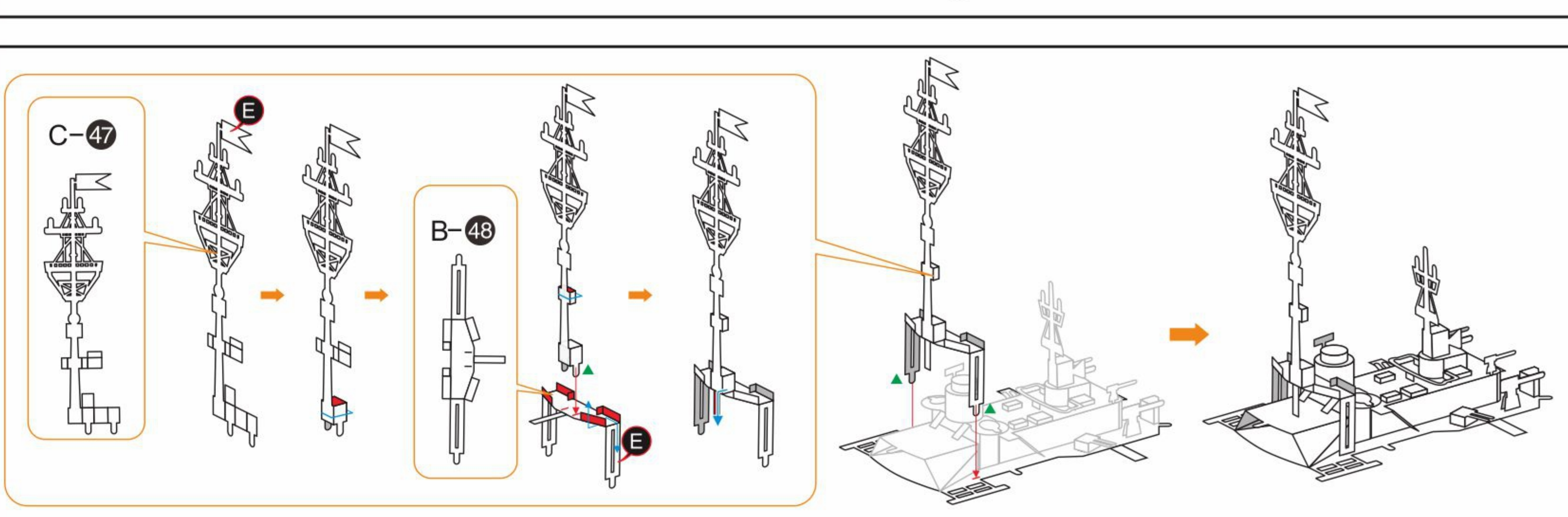
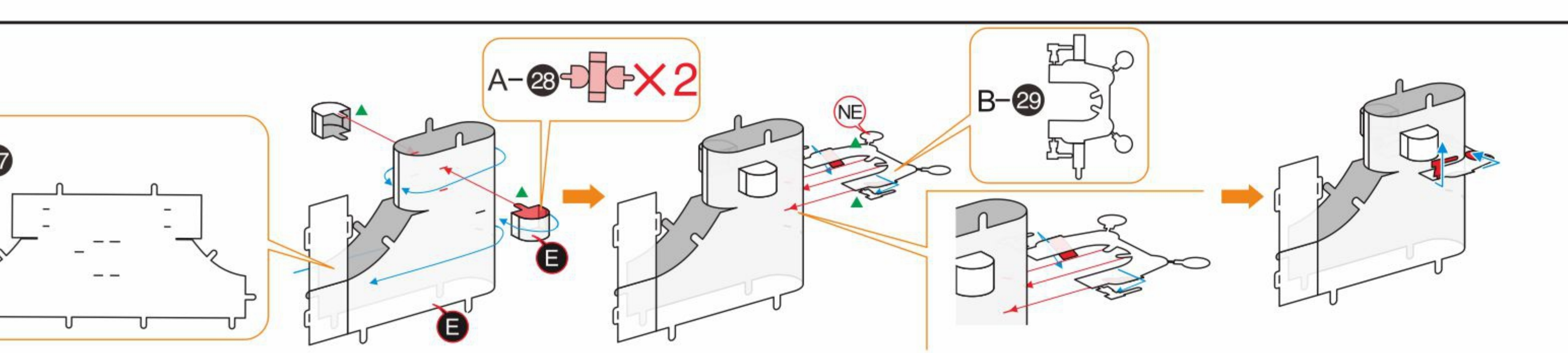
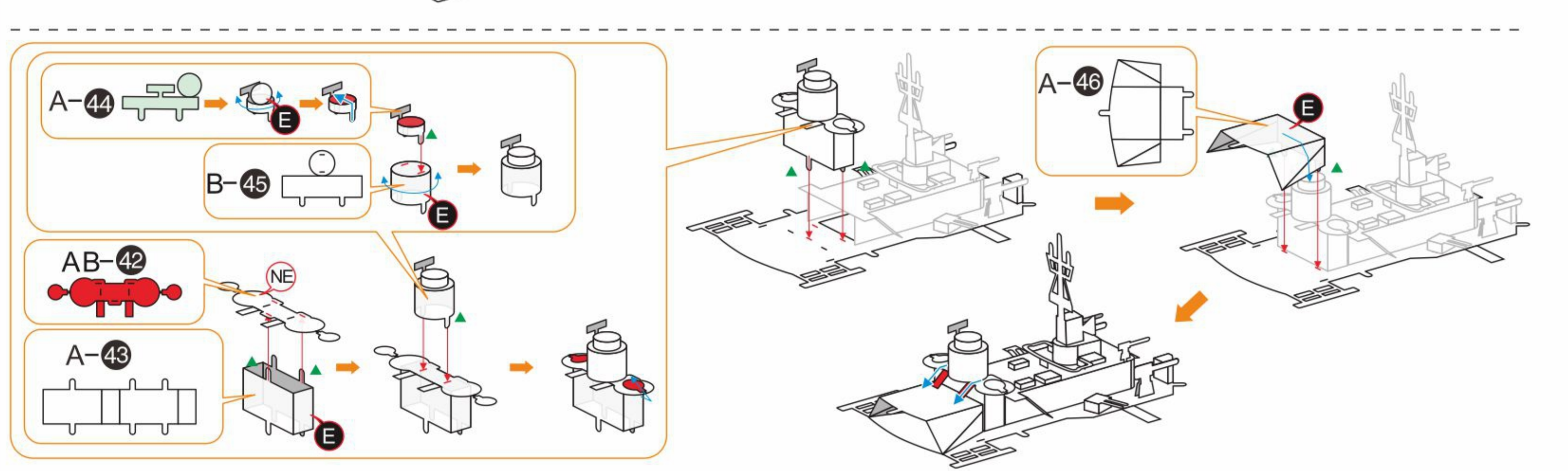
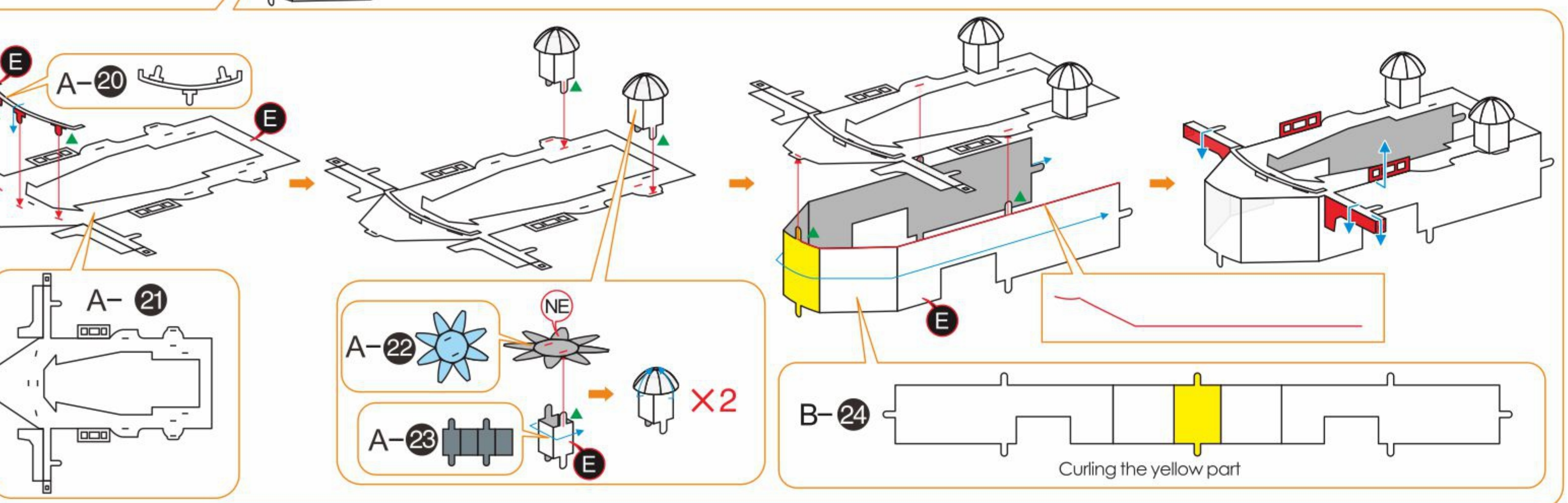
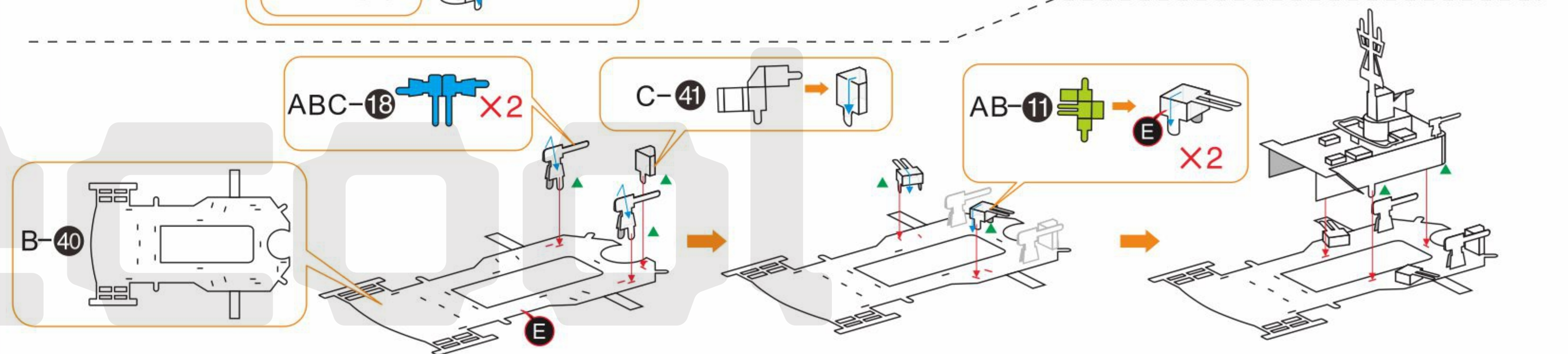
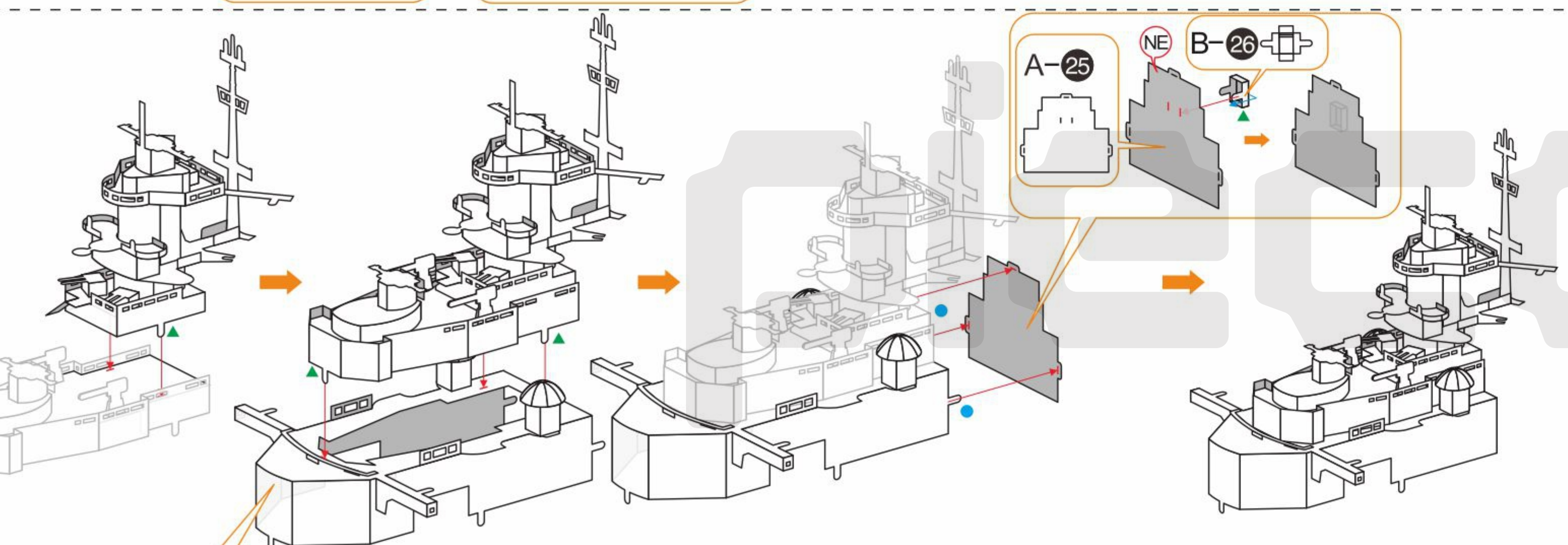
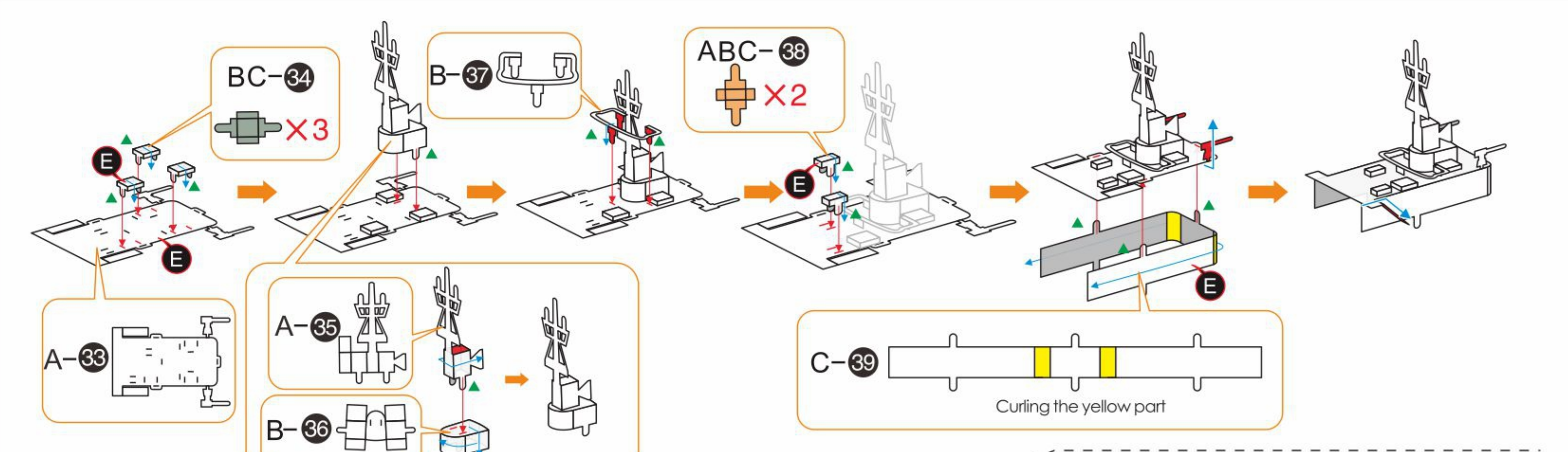
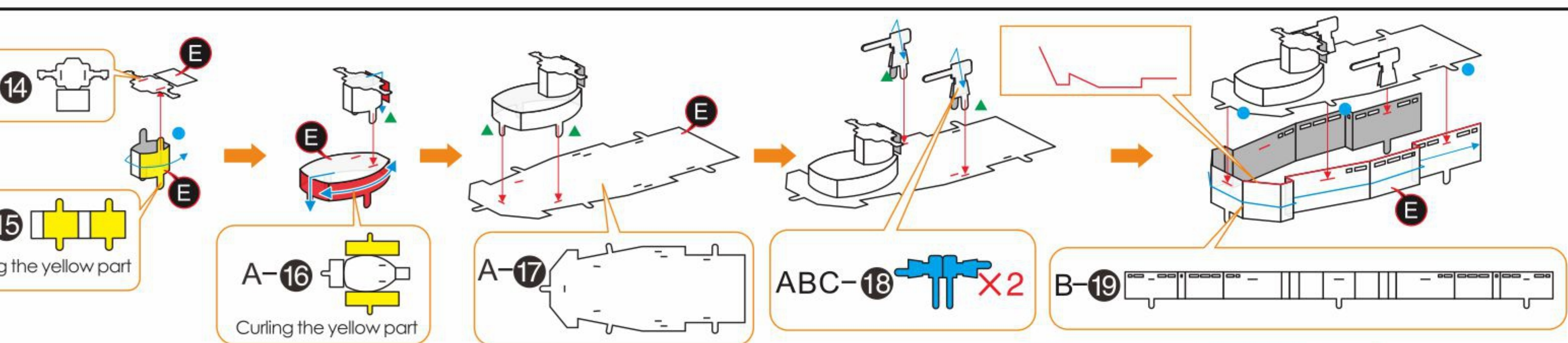
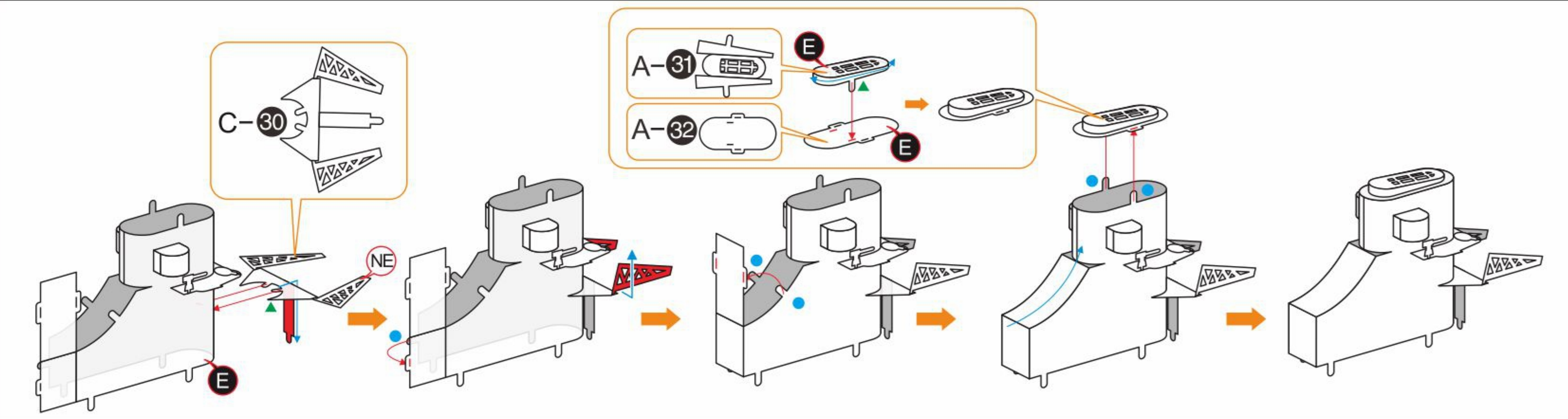
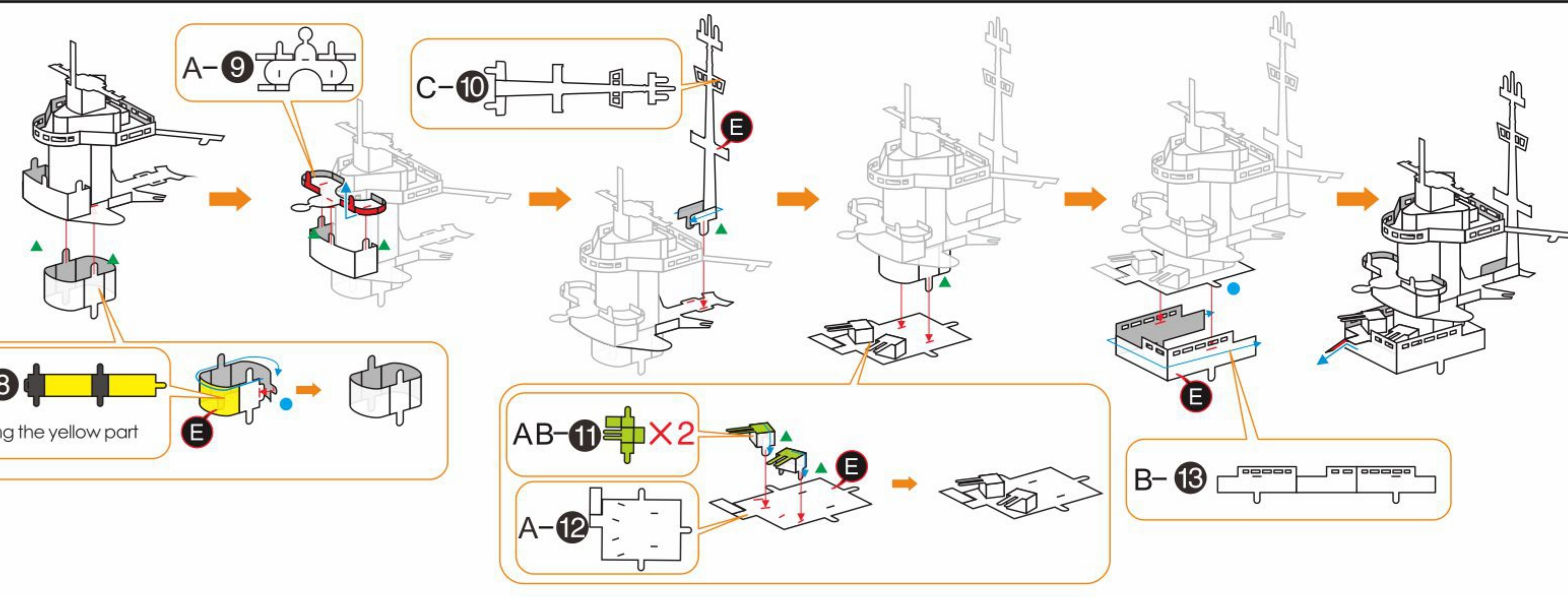

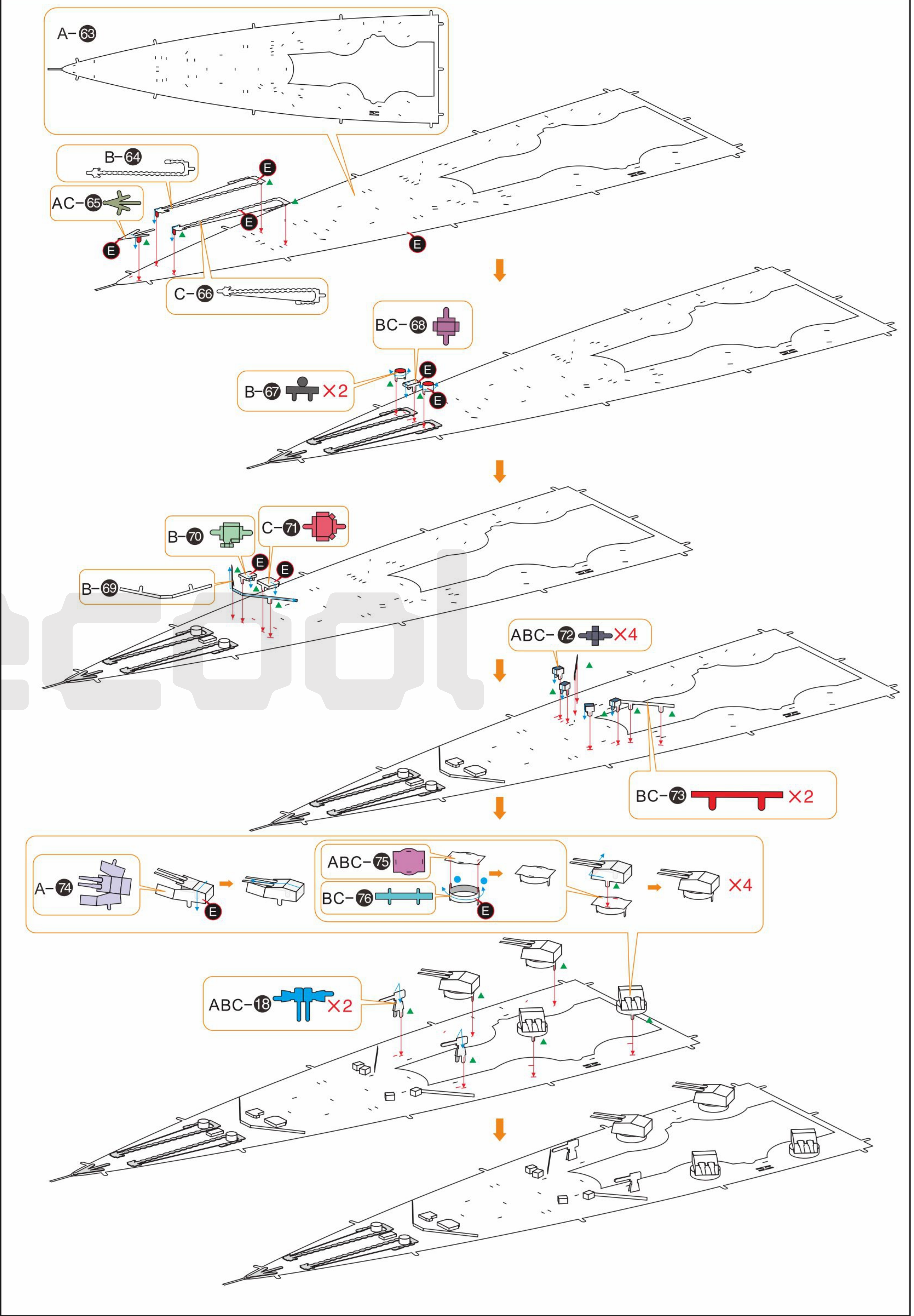
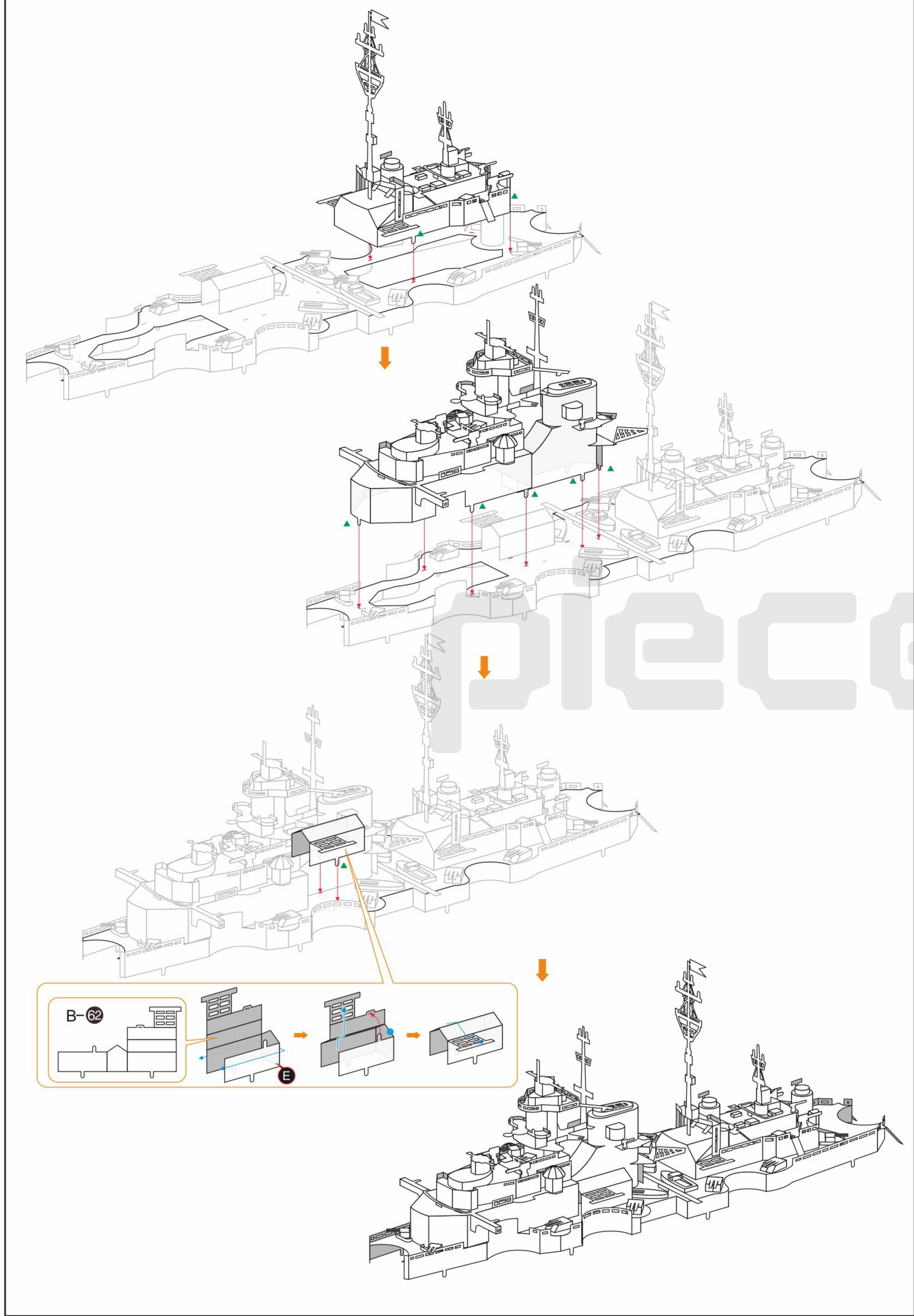
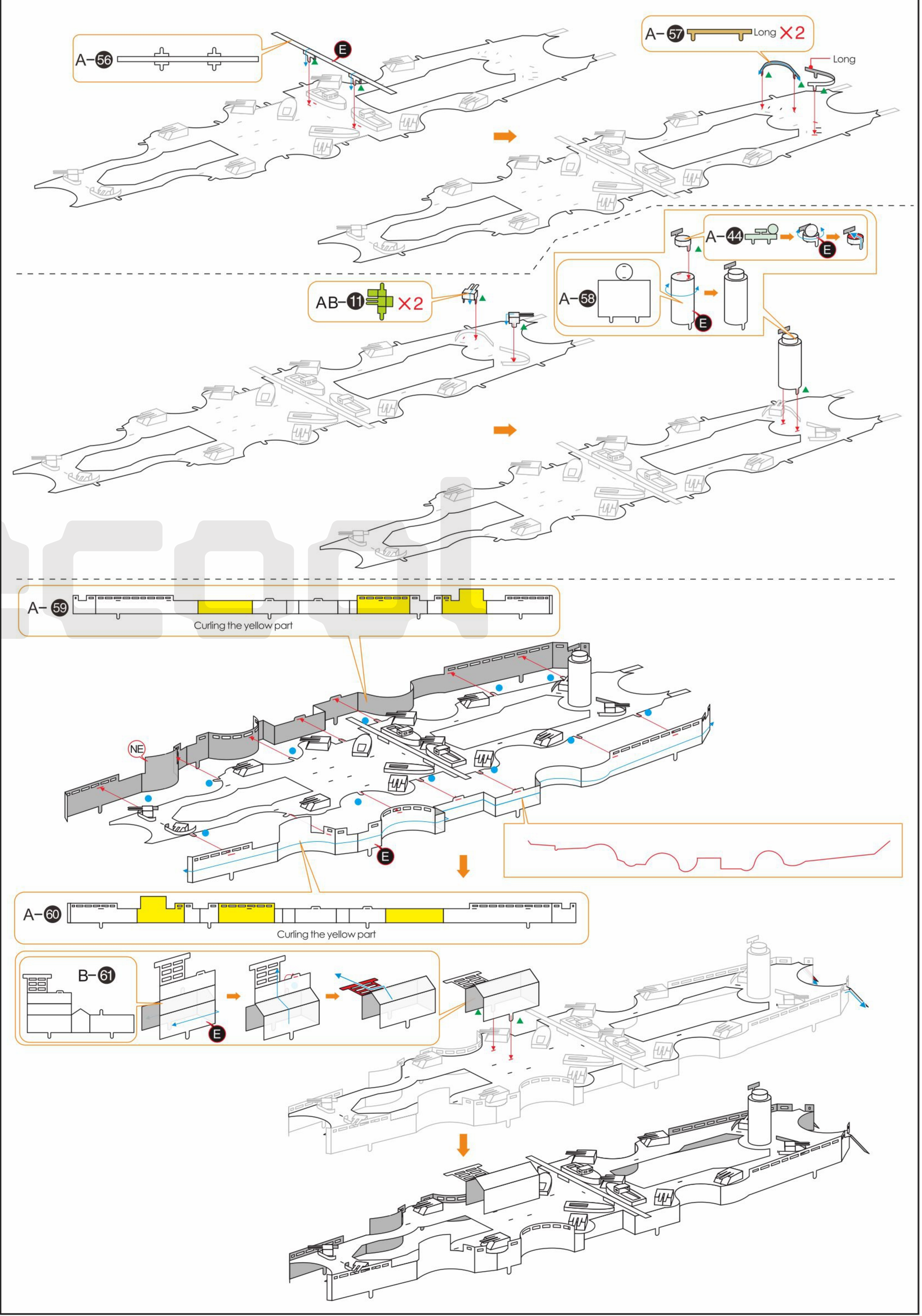
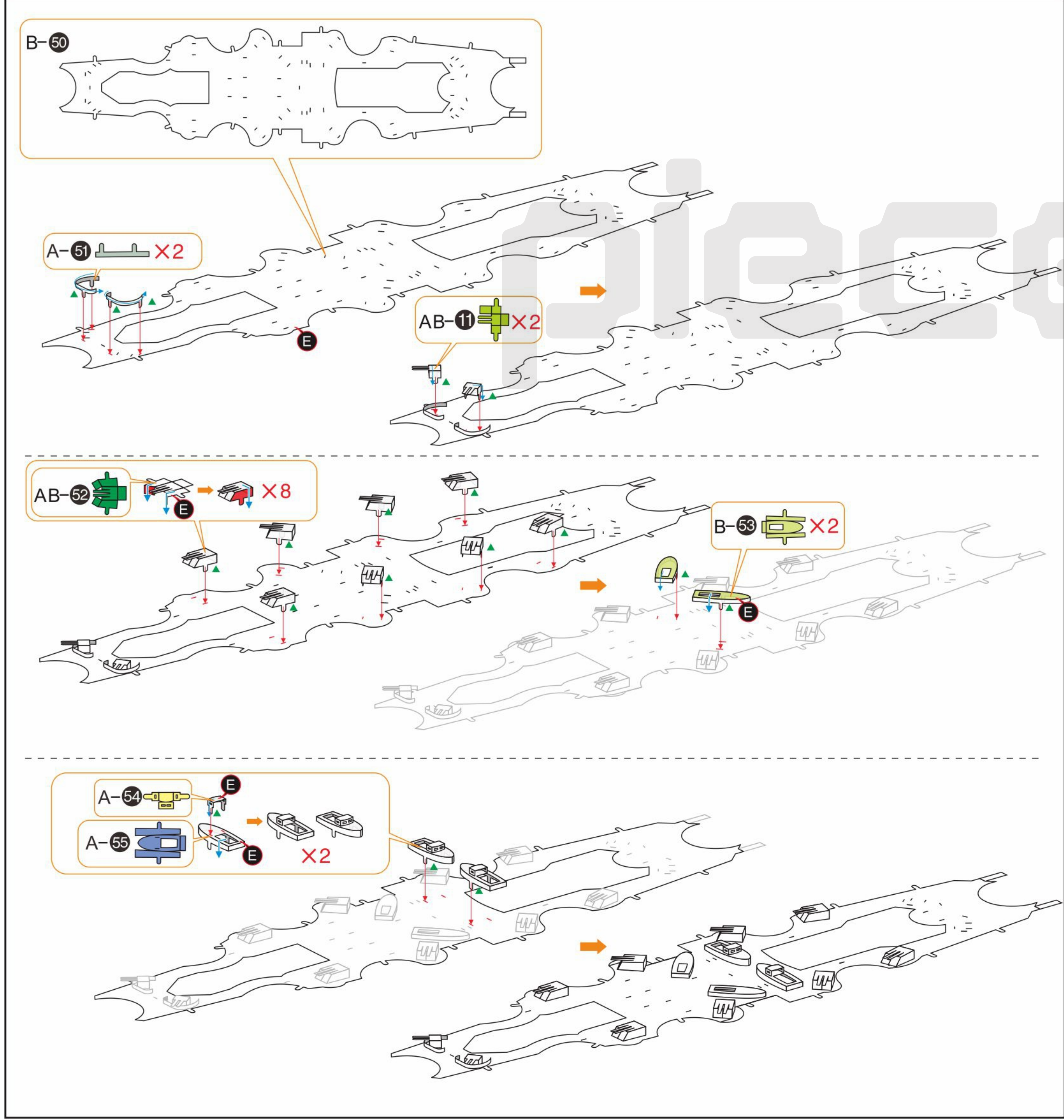
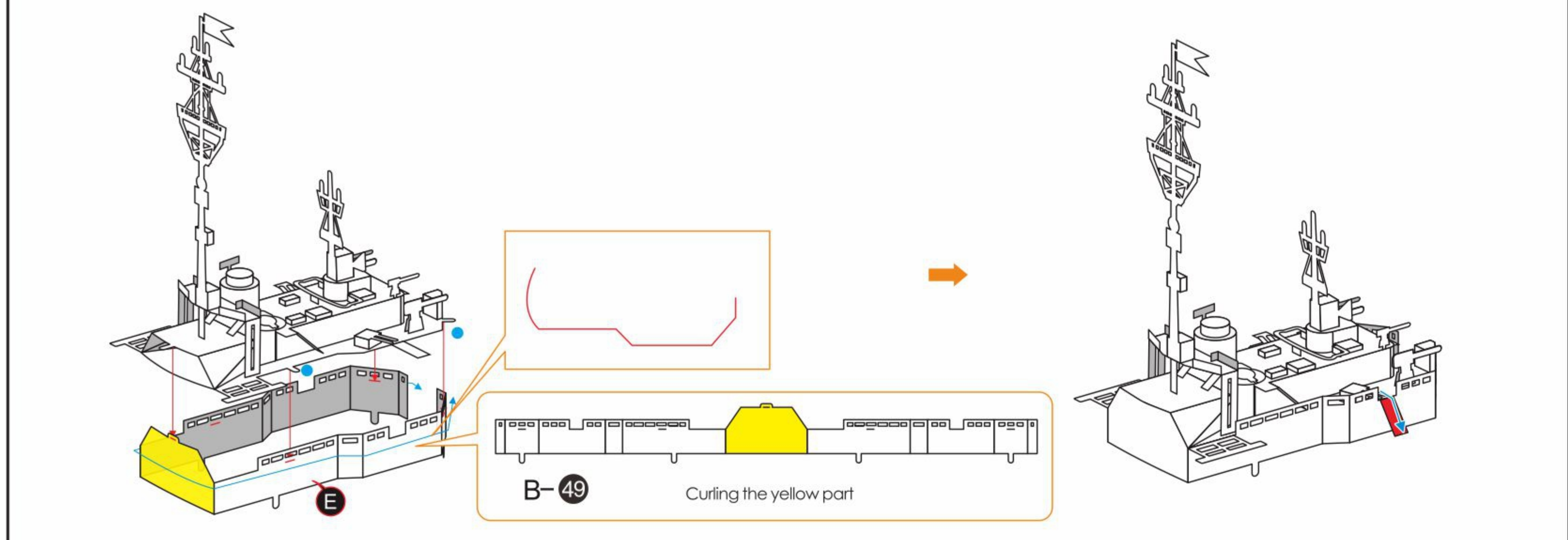

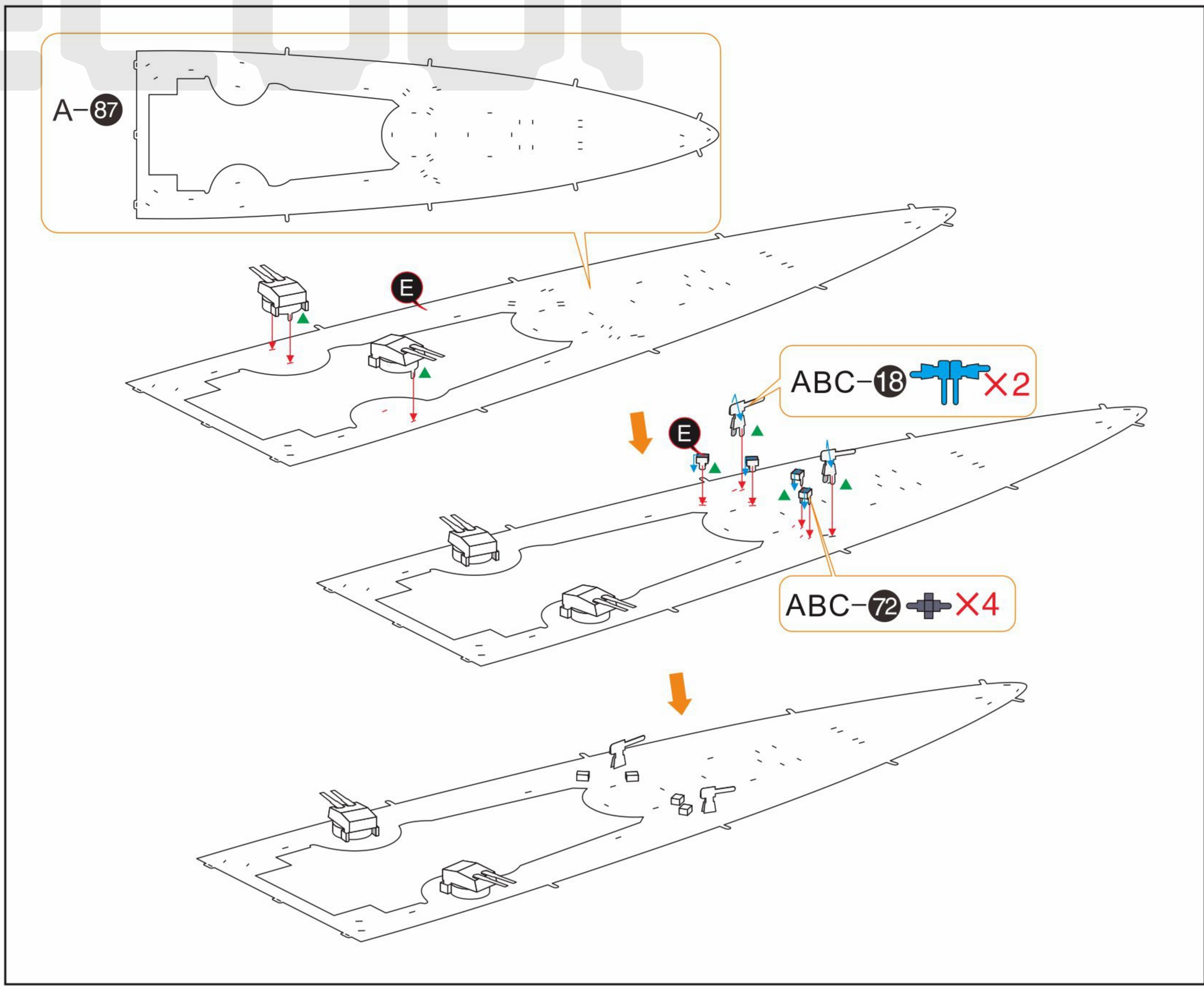
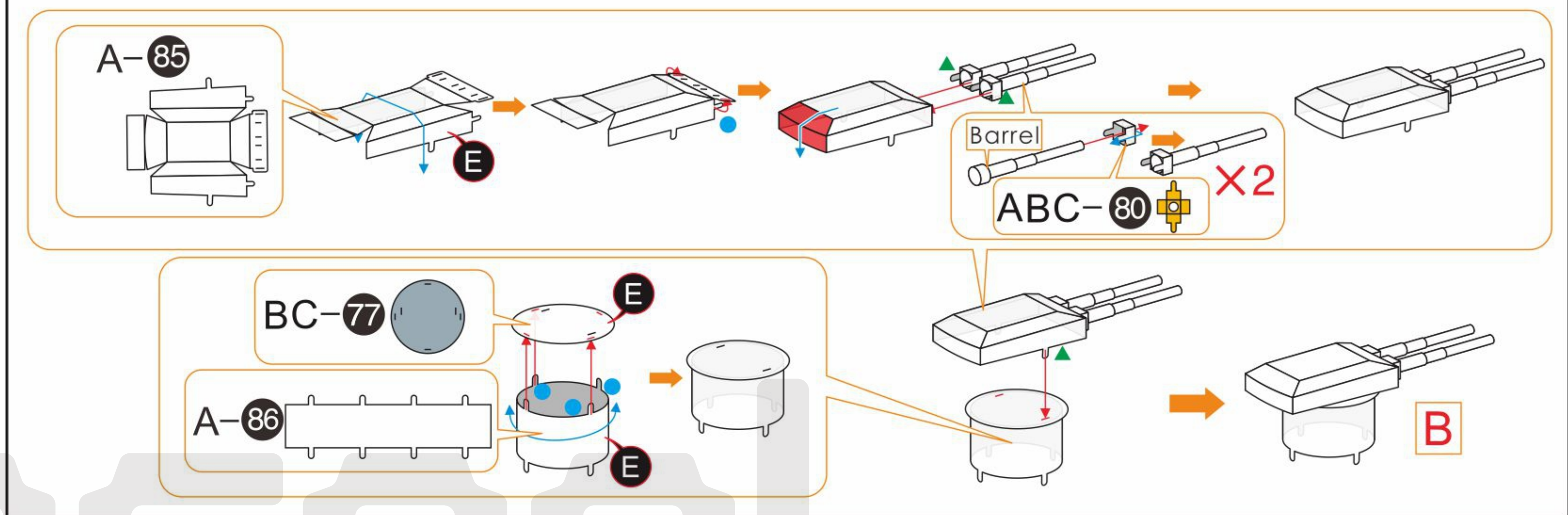
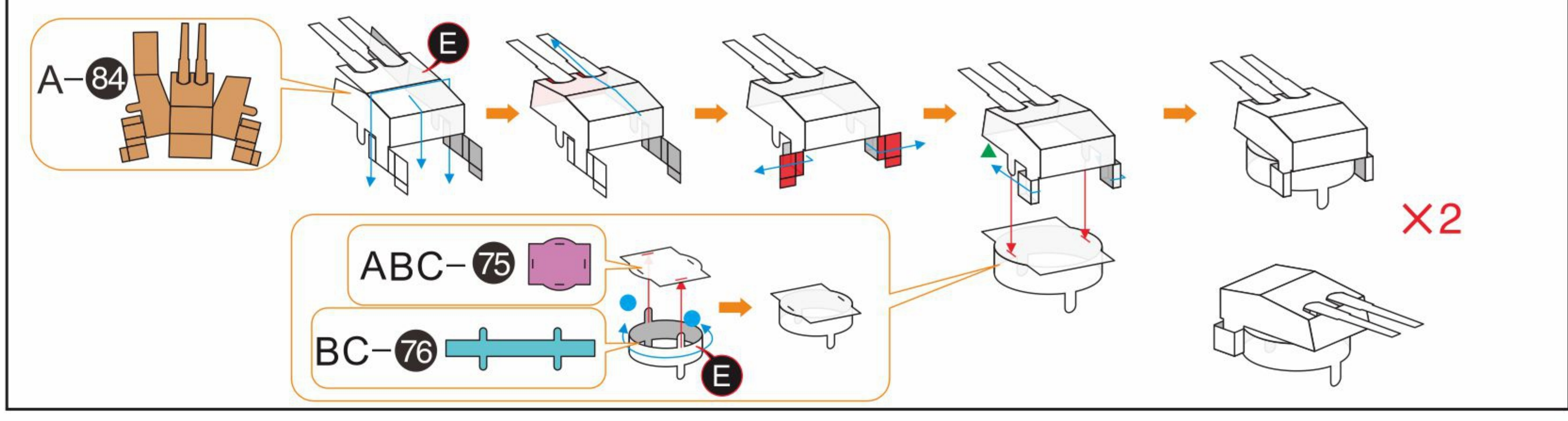
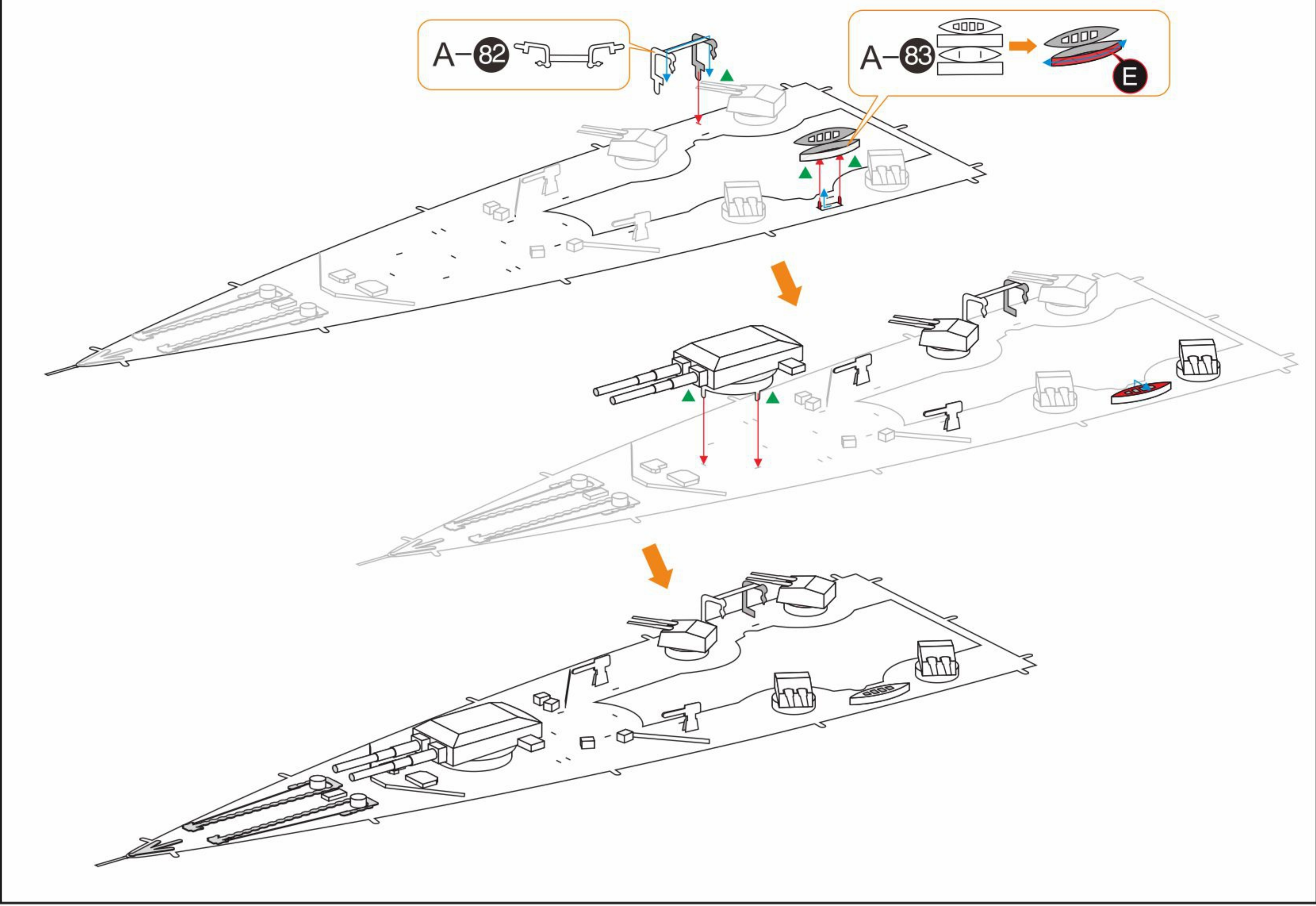
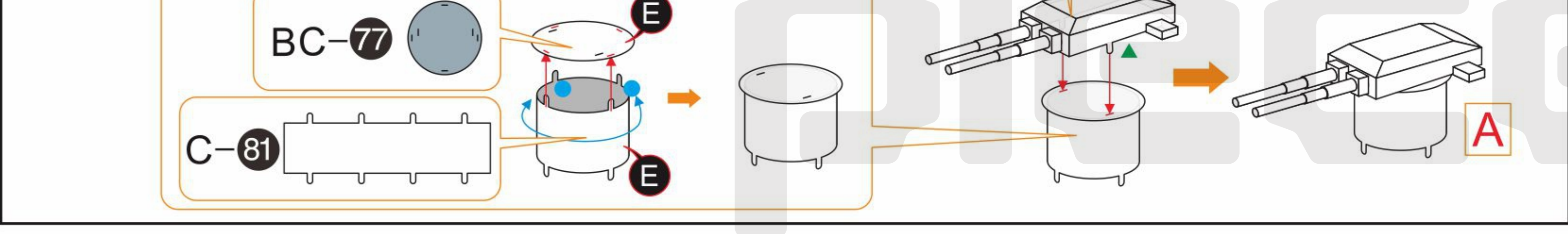
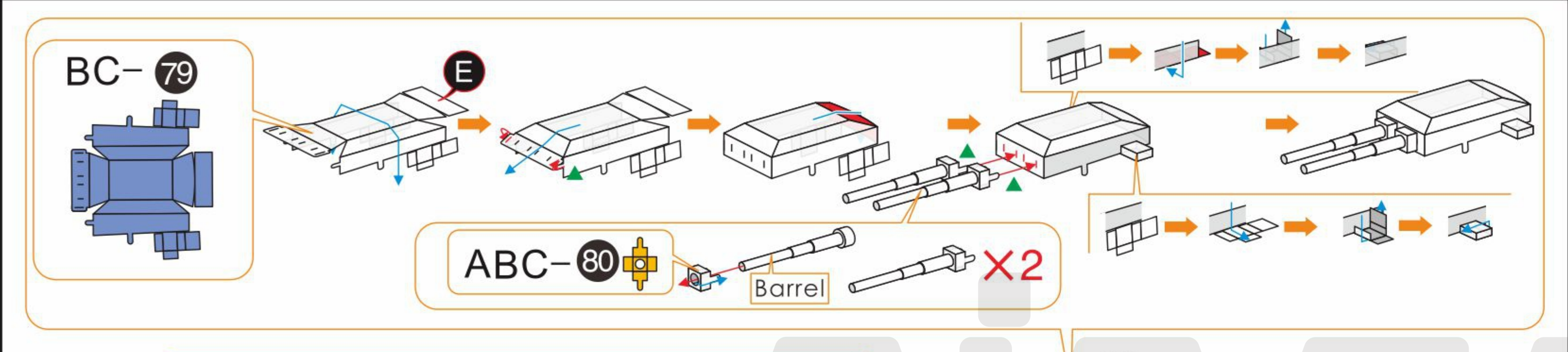
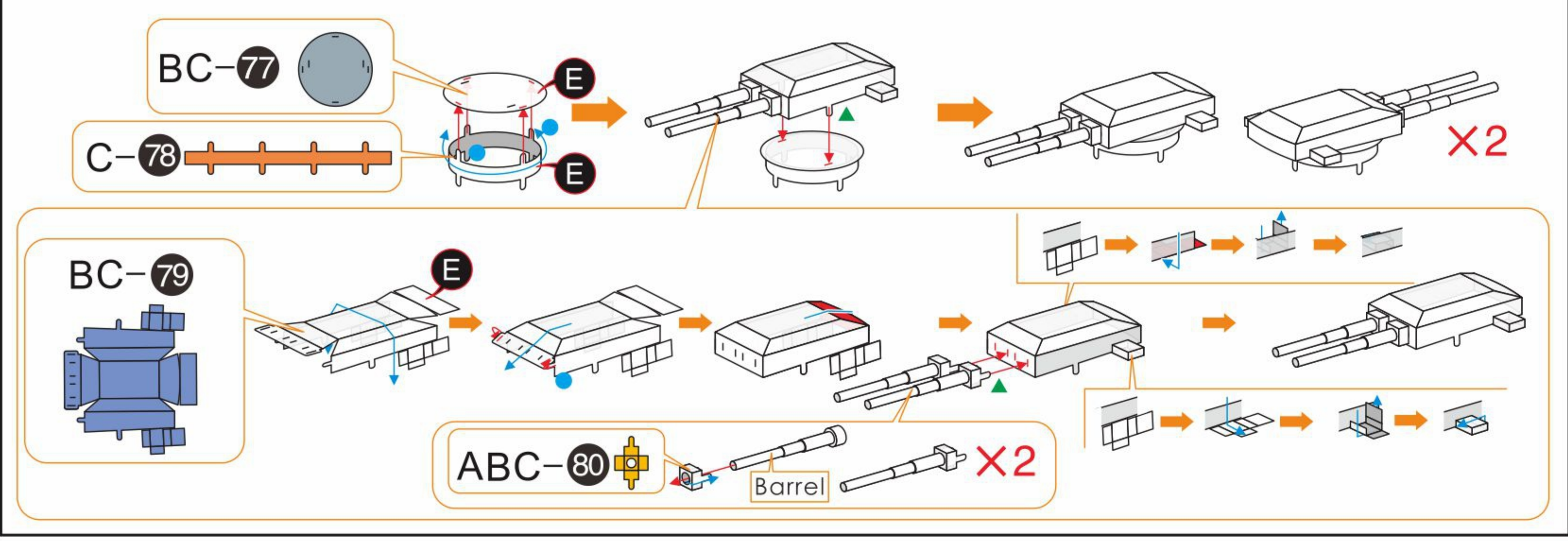

9 10
11 12

