

SELF PROPELLED GUN HP035

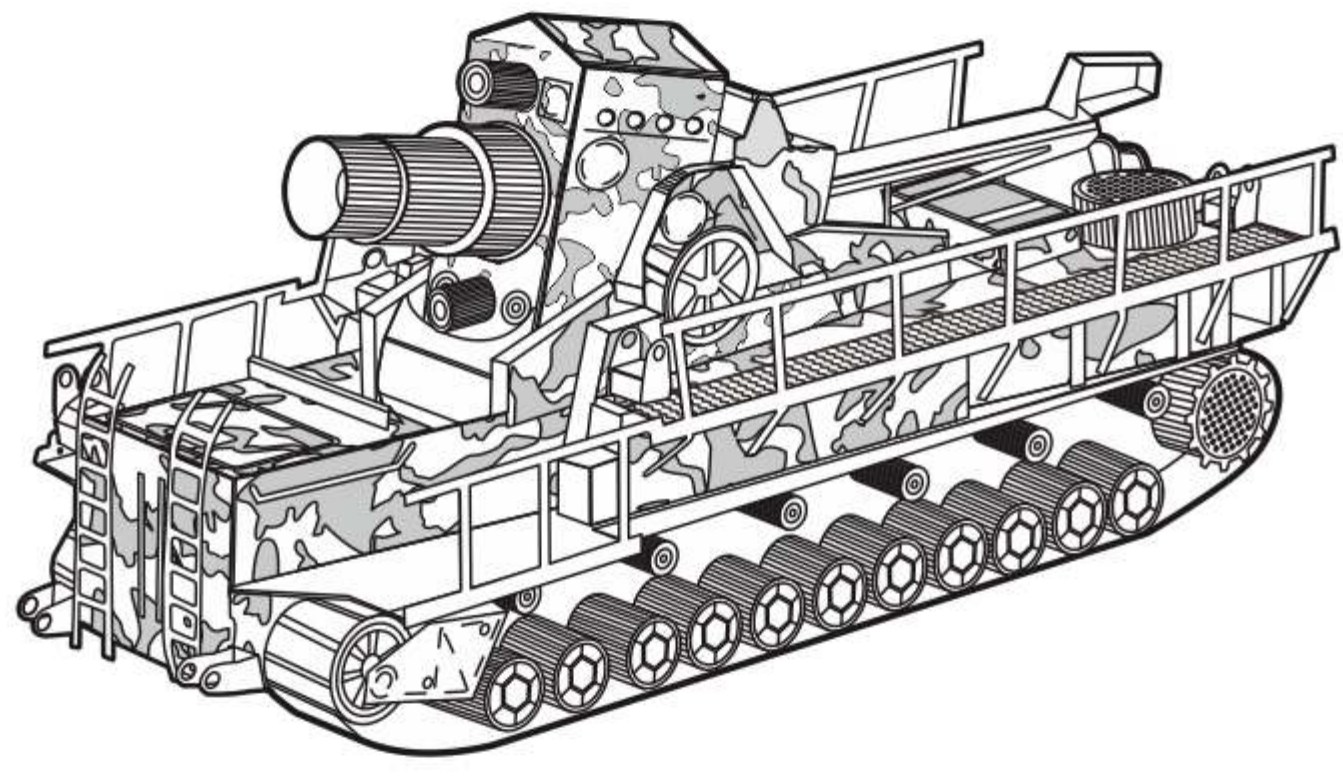

CP-ASSY-HP035#-A1-20210412

Installation Reminder

- Prepare tools:

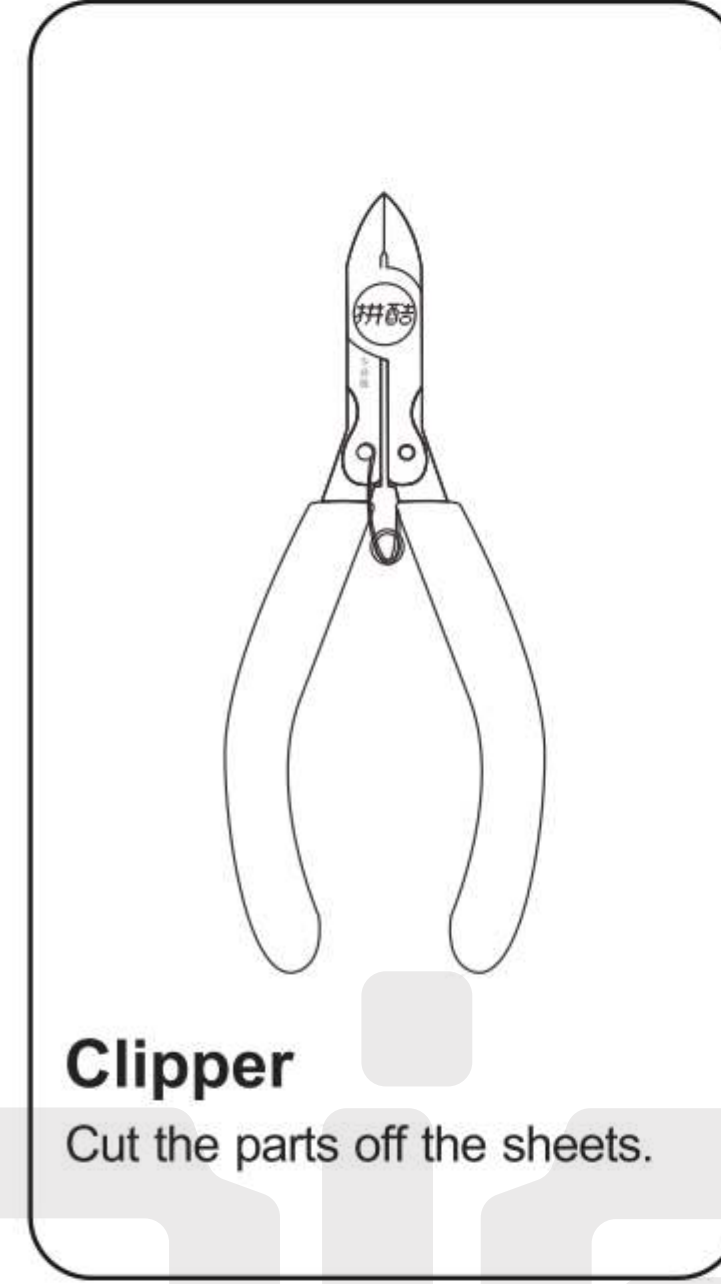

Clipper

Cut the parts off the sheets.

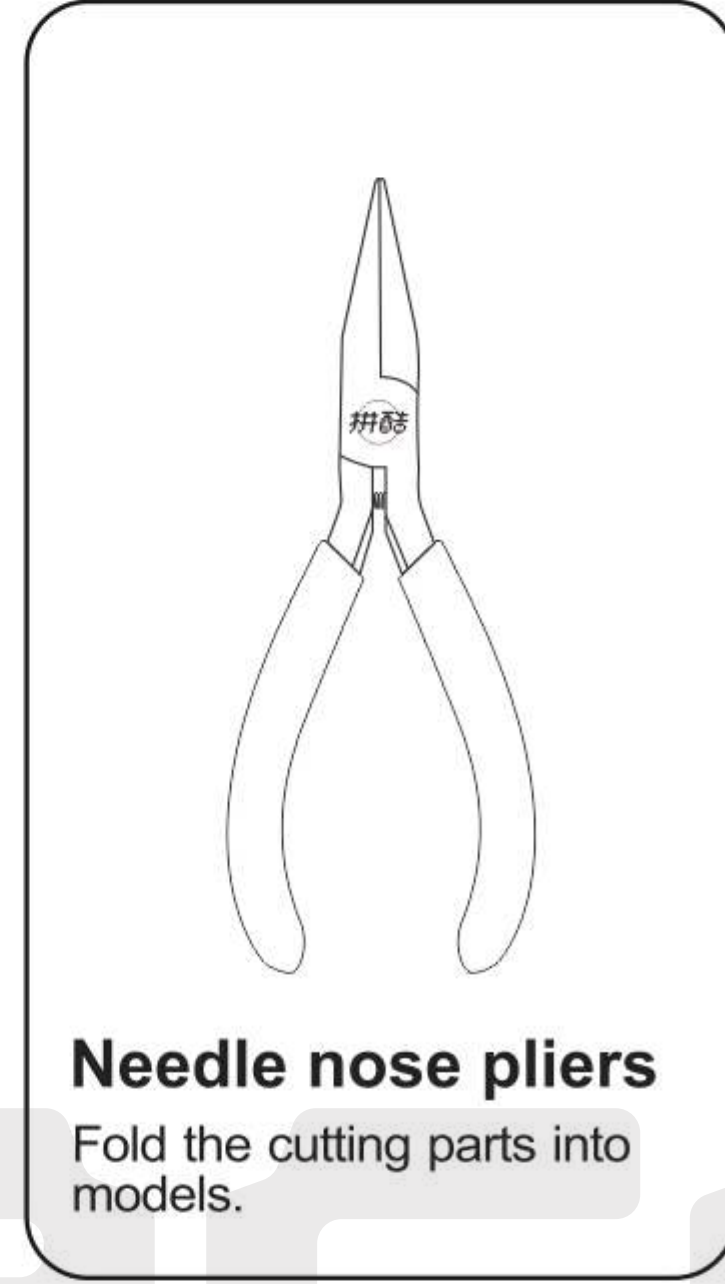

Needle nose pliers

Fold the cutting parts into models.

It is recommended to use piececool authentic assembly tools to build or fix the design. It is tailor made for the metal pieces and user friendly.

WARNING – Please handle metal sheets with care. The parts may have sharp edges that could cut or scratch skin. Keep away from children.

• Installation Method:

a. Remove the parts

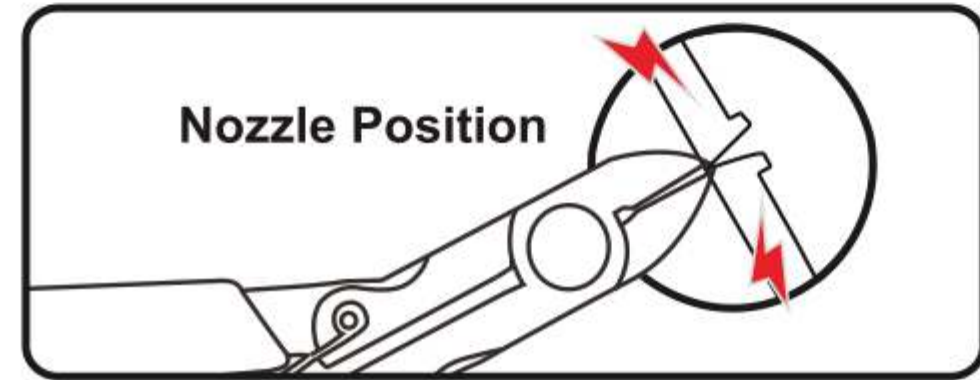

Please use the clipper to cut the nozzle position and remove the parts.

b. Identify the parts

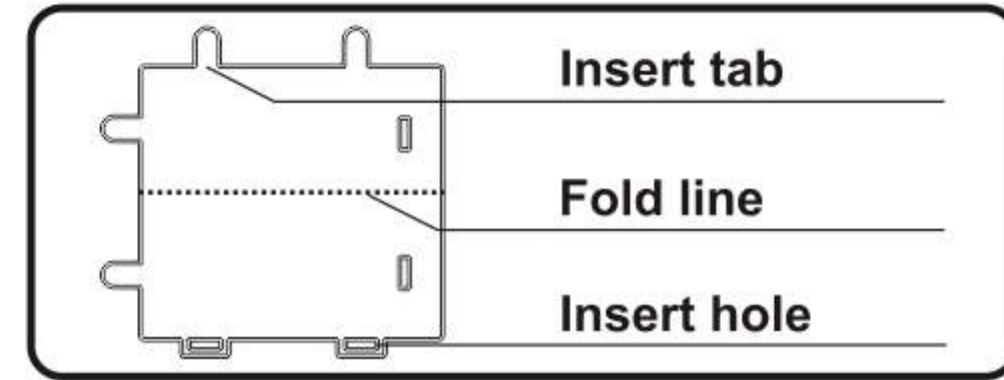

Identify the insert tab, fold line and the insert hole.

c. Folding the parts

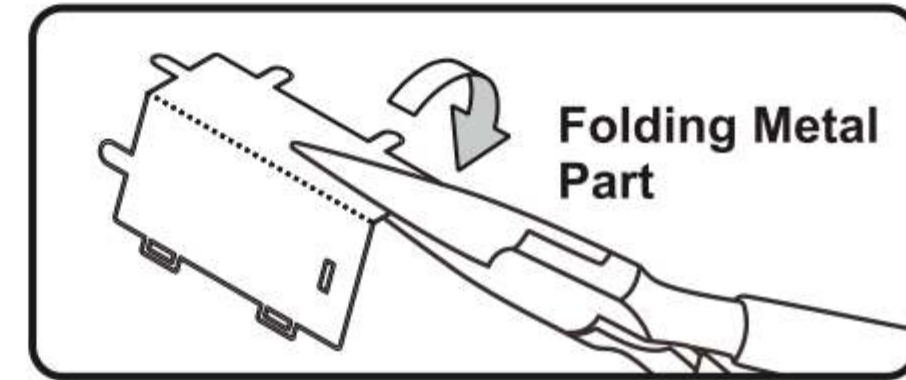

Please use the needle nose pliers to fold the cutting parts into models.

d. Retaining the parts

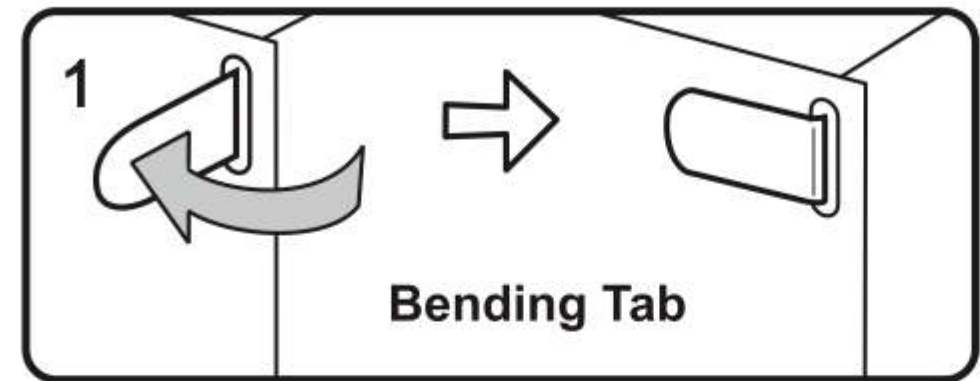

Insert the hole, bending tab with angle 90°

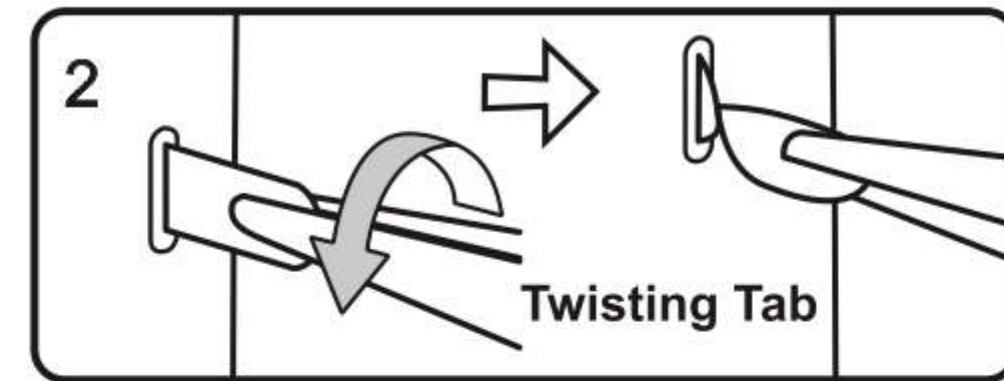

Insert the hole, twisting tab with angle 90°

• Attention:

- E** Engraved / Color side
- NE** Non-engraved / Silver side
- !** Attention Point
- ▭** Keep the parts symmetrical

When cutting metal parts, please do not cut the "insert tab" as "nozzle position". Only cut the parts of the current step when cutting the parts. Do not cut all the parts at one time to avoid loss.

When encountering the parts of the folding line, please pay attention to the front and back of the metal sheet and the direction of the folding. According to the direction indicated in the instruction, cut lightly and fold slowly. It is best to fold it once. Do not fold it repeatedly to avoid damage to the parts.

Assembly Guide

Step 1

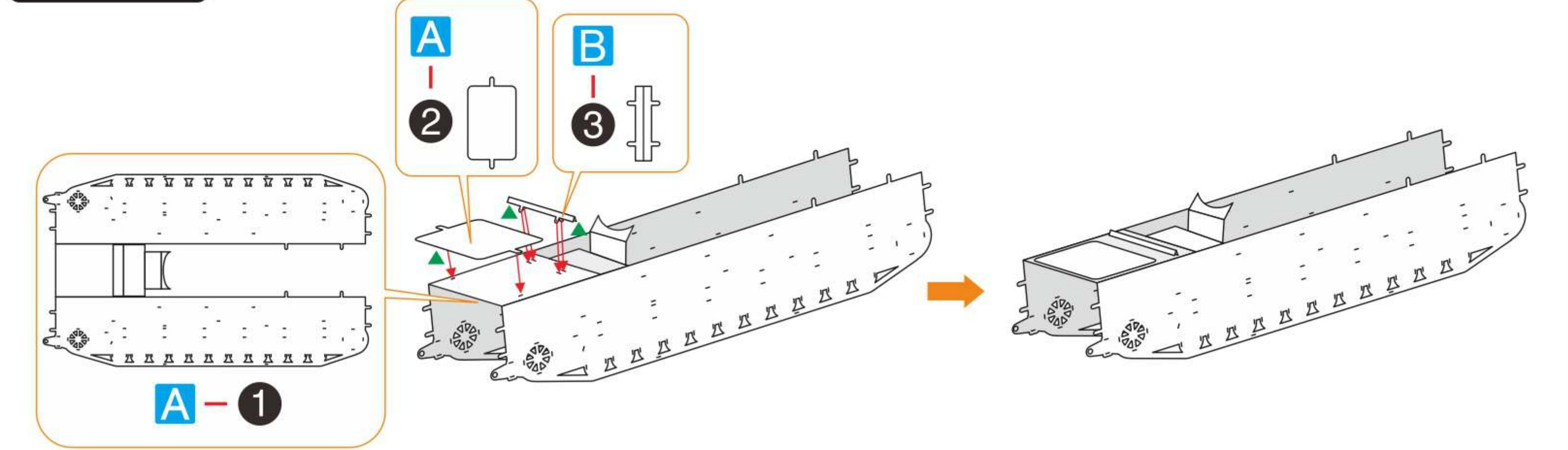

Step 2

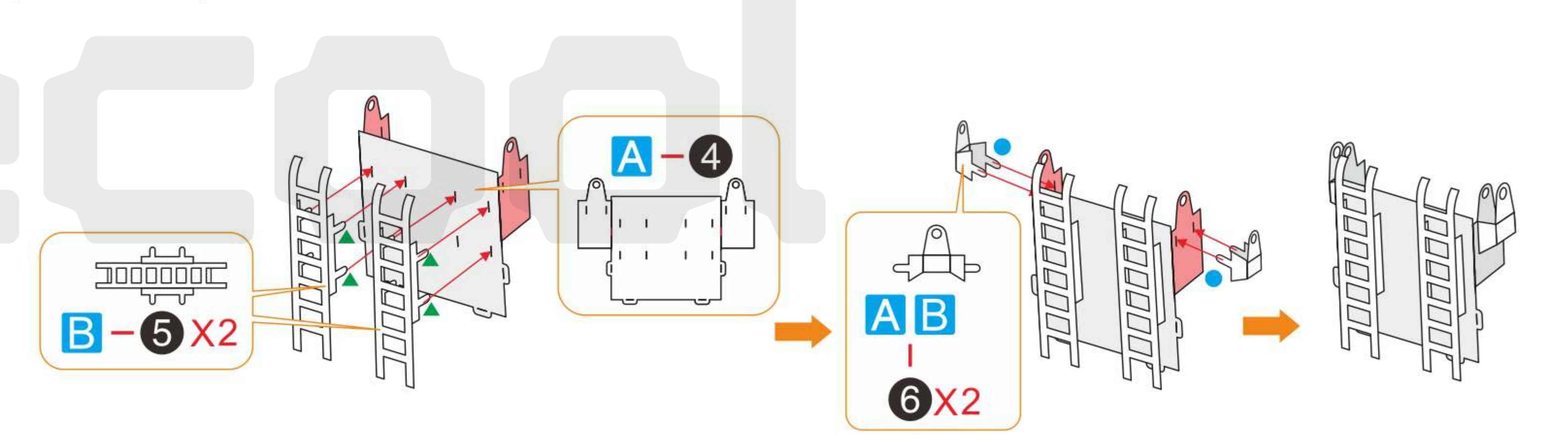

Step 3

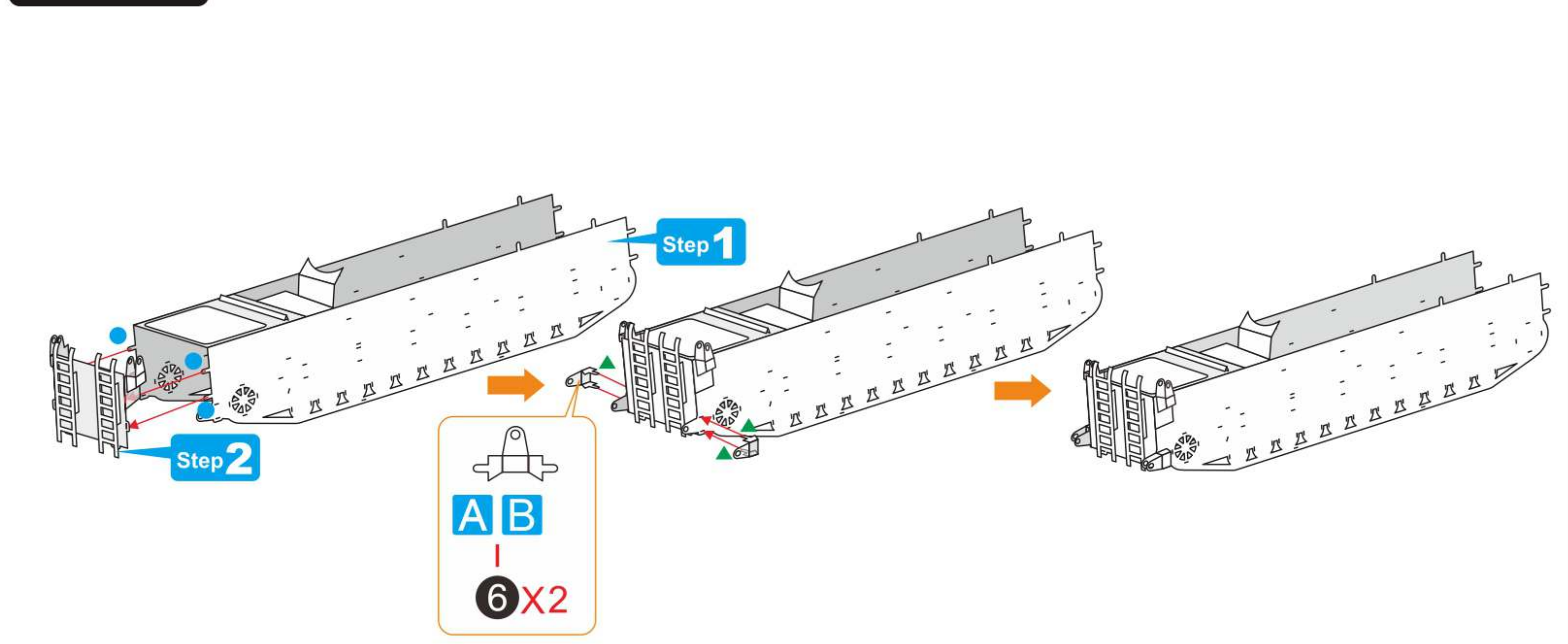

Step 4

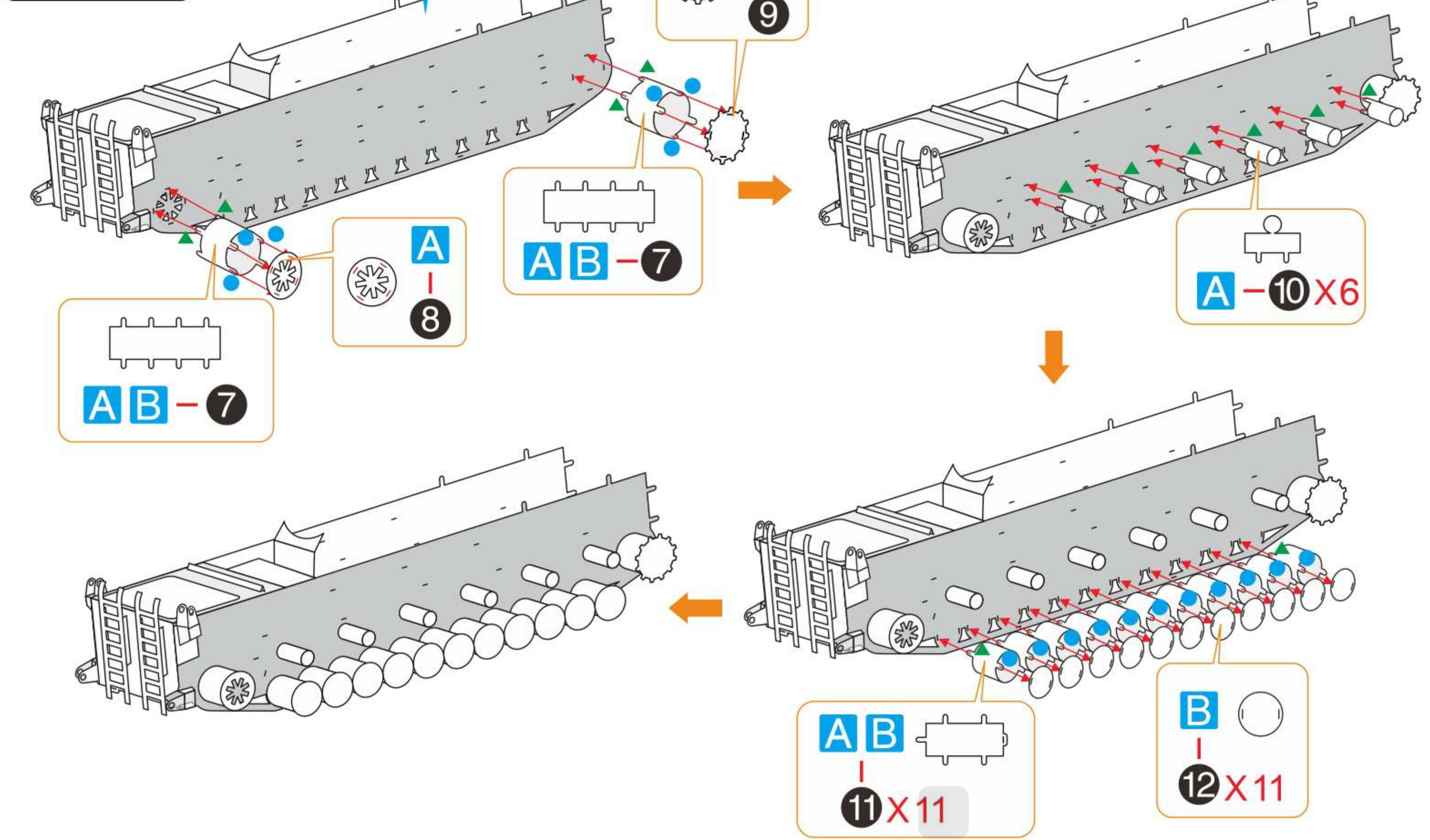

Step 5

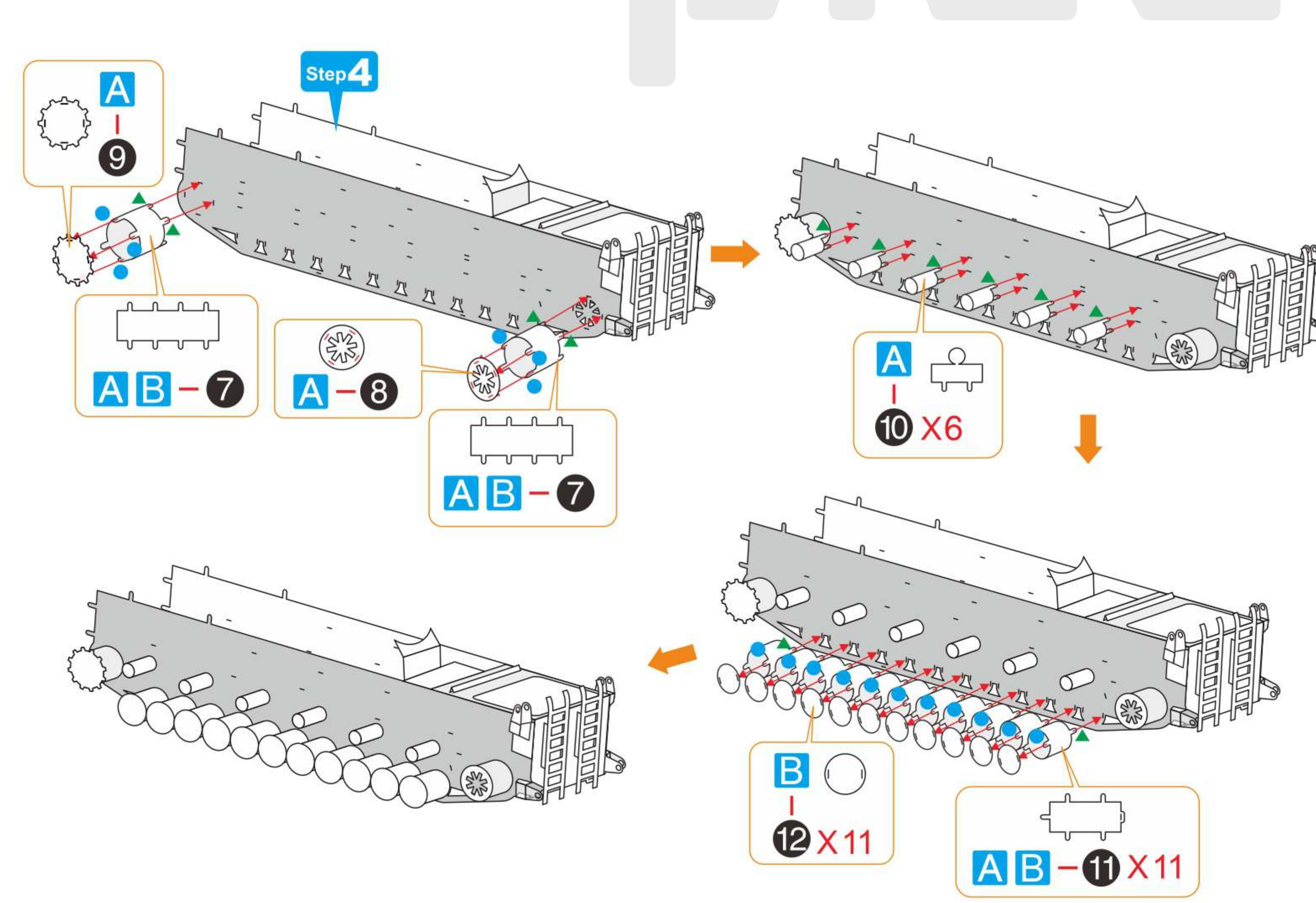

Step 6

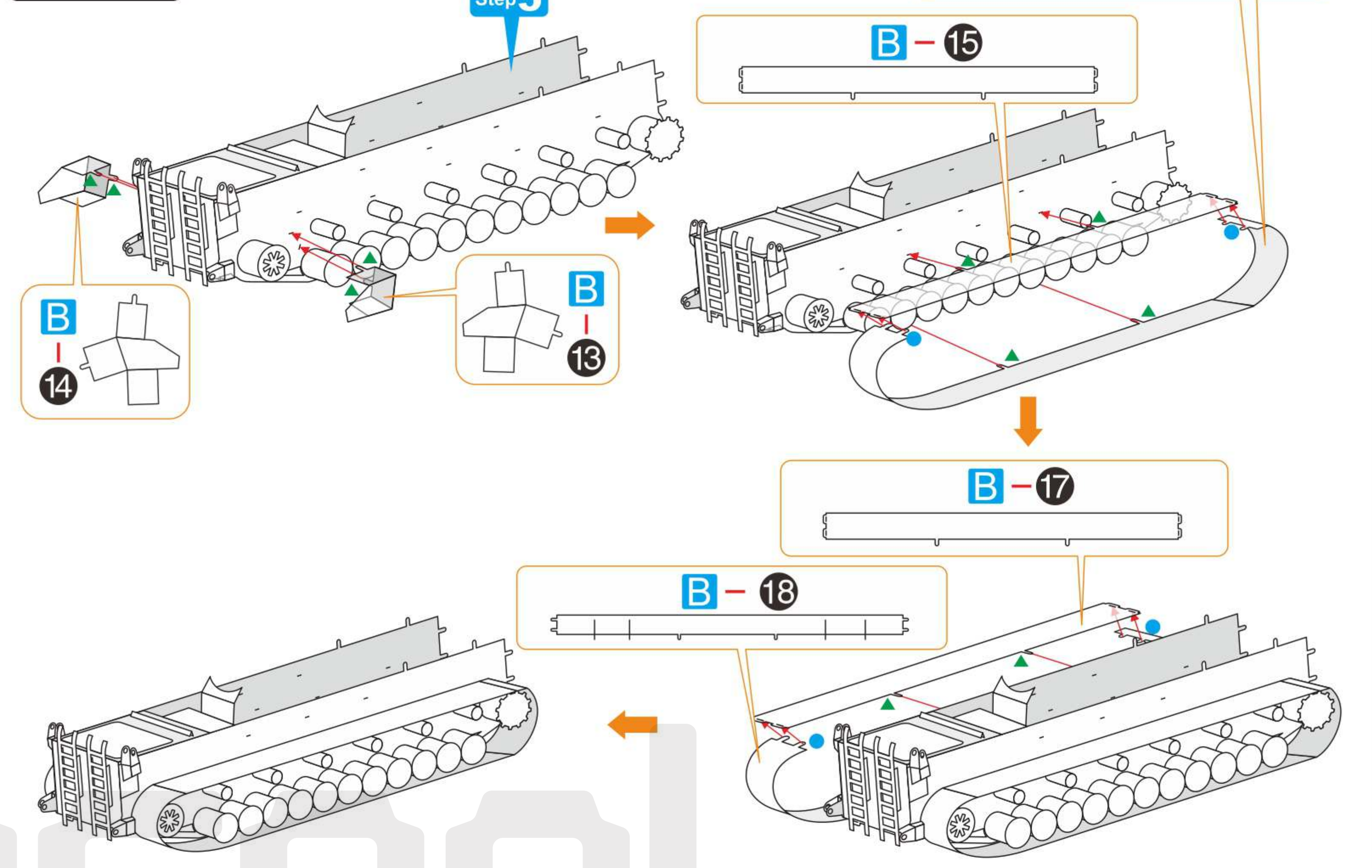

Step 7

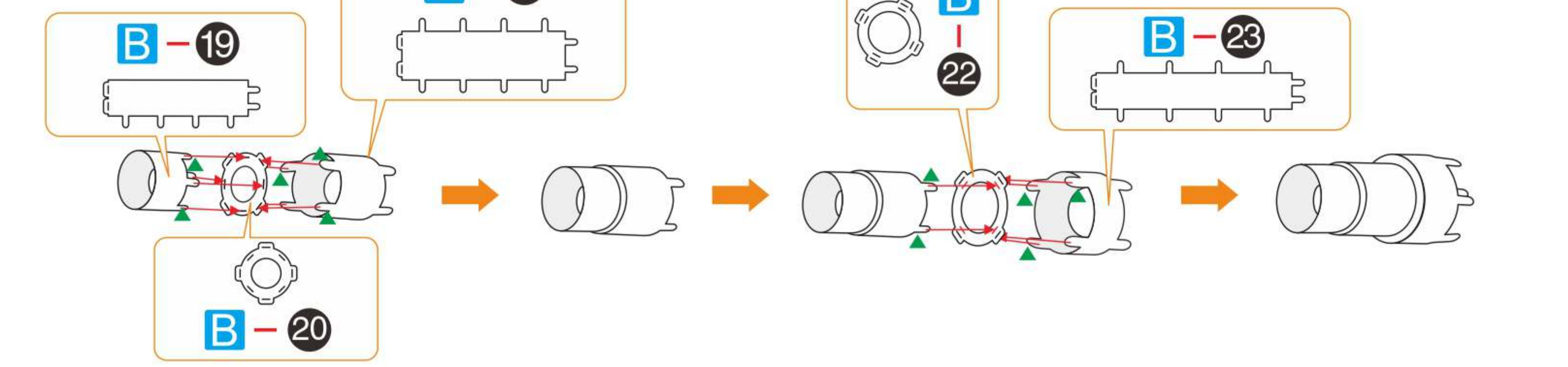

Step 8

